

EMB-QM77

Intel® 3rd Generation
Core™ i7/i5/Celeron® QC/DC Processor

Mini-ITX

Gigabit Ethernet

6 USB2.0, 4 USB3.0, 2 COM

2 SATA 6.0Gb/s, 2 SATA 3.0 Gb/s

1 PCI-E[x16], 1 Mini Card, 1 CFast™

Copyright Notice

This document is copyrighted, 2013. All rights are reserved. The original manufacturer reserves the right to make improvements to the products described in this manual at any time without notice.

No part of this manual may be reproduced, copied, translated, or transmitted in any form or by any means without the prior written permission of the original manufacturer. Information provided in this manual is intended to be accurate and reliable. However, the original manufacturer assumes no responsibility for its use, or for any infringements upon the rights of third parties that may result from its use.

The material in this document is for product information only and is subject to change without notice. While reasonable efforts have been made in the preparation of this document to assure its accuracy, AAEON assumes no liabilities resulting from errors or omissions in this document, or from the use of the information contained herein.

AAEON reserves the right to make changes in the product design without notice to its users.

Acknowledgments

All other products' name or trademarks are properties of their respective owners.

- AMI is a trademark of American Megatrends Inc.
- CompactFlash™ is a trademark of the Compact Flash Association.
- Intel®, Core™ and Celeron® are trademarks of Intel® Corporation.
- Microsoft Windows® is a registered trademark of Microsoft Corp.
- ITE is a trademark of Integrated Technology Express, Inc.
- IBM, PC/AT, PS/2, and VGA are trademarks of International Business Machines Corporation.
- SoundBlaster is a trademark of Creative Labs, Inc.

Please be notified that all other products' name or trademarks not be mentioned above are properties of their respective owners.

Packing List

(Standard, not bulk pack)

Before you begin installing your card, please make sure that the following materials have been shipped:

- 1 Jumper Cap
- 1 USB Cable w/Bracket
- 1 COM Cable
- 2 Screws for Mini Card socket
- 1 VGA Cable
- 1 SATA Cable 7P
- 1 SATA PWR Cable 4P
- 1 Back I/O Shield
- 1 Product DVD-ROM
- 1 EMB-QM77

If any of these items should be missing or damaged, please contact your distributor or sales representative immediately.

Contents

Chapter 1 General Information

1.1 Introduction.....	1-2
1.2 Features	1-3
1.3 Specifications	1-4

Chapter 2 Quick Installation Guide

2.1 Safety Precautions	2-2
2.2 Location of Connectors and Jumpers	2-3
2.3 Mechanical Drawing	2-5
2.4 List of Jumpers	2-7
2.5 List of Connectors	2-7
2.6 Setting Jumpers	2-9
2.7 Clear CMOS (CMOS1).....	2-10
2.8 Auto Power Button (JP1).....	2-10
2.9 Clear ME (JP2).....	2-10
2.10 LVDS & Inverter Voltage Selection (JP3)	2-10
2.11 LVDS Backlight Brightness Control Selection (JP4)	2-10
2.12 +12V/+5V/RING Selection (JP5).....	2-11
2.13 Front Panel Connector (CN3)	2-11
2.14 LVDS Connector (CN5).....	2-11
2.15 LVDS Inverter Power Wafer (CN6)	2-12
2.16 DVI-D/ COM2 Port Connector (CN11)	2-13

2.17 LVDS Analyze Degree Selection (CN17).....	2-15
2.18 Digital I/O (DIO1).....	2-16
2.19 SATA Power (PWR1~PWR2)	2-17
2.20 RS-232 Box Header (COM 1)	2-17
2.21 USB Box Header (USB1 ~ USB3)	2-17

Chapter 3 AMI BIOS Setup

3.1 System Test and Initialization.	3-2
3.2 AMI BIOS Setup.....	3-3

Chapter 4 Driver Installation

4.1 Installation.....	4-3
-----------------------	-----

Appendix A Programming The Watchdog Timer

A.1 Programming	A-2
A.2 ITE8728 Watchdog Timer Initial Program.....	A-6

Appendix B I/O Information

B.1 I/O Address Map	B-2
B.2 Memory Address Map.....	B-4
B.3 IRQ Mapping Chart.....	B-5
B.4 DMA Channel Assignments.....	B-7

Appendix C Mating Connector

C.1 List of Mating Connectors and Cables.....	C-2
---	-----

Appendix D RAID & AHCI Settings

D.1 Setting RAID	D-2
------------------------	-----

D.2 Setting AHCI D-12

Chapter

1

**General
Information**

1.1 Introduction

The EMB-QM77 supports Intel® Socket G2 (rPGA988B) 3rd Generation Intel® Core™ i7/i5/Celeron® QC/DC processor which when paired with the Intel® QM77 chipset offers a high performance computing platform with low power consumption. This new product supports two 204-pin dual-channel DDR3 SODIMM at speeds of 1066/1333/1600 MHz, up to 8 GB.

One CFast™, two SATA 6.0Gb/s and two SATA 3.0 Gb/s interfaces provide ample storages. With dual Gigabit Ethernet, two COM ports, four USB3.0, and six USB2.0, the EMB-QM77 meets the requirements of today's demanding applications.

Display requirements are met with an abundance of interfaces such as CRT (with optional CRT cable), DVI, HDMI, DisplayPort™ and LVDS. The graphic engine adopts 3rd generation Intel® Core™i7/ i5/ Celeron® integrated Gfx Gen 5.75 graphics to offer high definition display function.

With all of its integrated features, the EMB-QM77 strikes a balance of performance and price. This versatile product targets Industrial Automation, Entertainment, Networking, KIOSK/POS, Transportation, Banking, Healthcare and Digital Signage applications that require high performance and high reliability.

1.2 Features

- Socket rPGA988B, Intel® 3rd Generation Core™ i7/i5/Celeron® Processor
- Intel® 3rd Generation Core™ i7/i5 + QM77
- 204-pin Dual-channel DDR3 1066/1333/1600 MHz SODIMM x 2, Up to 8 GB
- Gigabit Ethernet x 2
- Dual Display Version: CRT, Dual 24-bit LVDS, DVI-D, HDMI, DisplayPort™
- Three Display Version: CRT, Dual 24-bit LVDS, DVI-D, DisplayPort™ x 2 (Optional)
- SATA 6.0Gb/s x 2, SATA 3.0Gb/s x 2, Support RAID 0,1,5,10
- USB2.0 x 6, USB3.0 x 4, COM x 2
- PCI-Express [x16] x 1, Mini Card x 1, CFast™ x 1, TPM

1.3 Specifications

System

- | | |
|-------------------------|--|
| ● From Factor | Mini-ITX |
| ● Processor | Socket G2 (rPGA988B) 3rd Generation Intel® Core™ i7 / i5 / Celeron® QC /DC processor |
| ● System Memory | 204-pin Dual Channel DDR3 1066/1333/1600 MHz SODIMM x 2, up to 8GB |
| ● Chipset | Intel® Core i7/i5 + QM77 |
| ● Ethernet | Intel® PHY WG82579LM, Gigabit Ethernet, RJ-45 x 1;
Realtek RTL8111E Gigabit Ethernet, RJ-45 x 1 |
| ● BIOS | AMI SPI BIOS-128Mb ROM |
| ● Wake On LAN | Yes |
| ● Watchdog Timer | Reset: 1 sec. ~ 255 steps programmable |
| ● H/W Status Monitoring | System temperature, voltage, and cooling fan status monitoring |
| ● Expansion Interface | PCI-E [x16] x 1, Mini Card x 1, CFast™ x 1, TPM |
| ● Battery | Lithium Battery |
| ● Power Requirement | 12V DC-IN |
| ● Board Size | 6.7" x 6.7" (170mm x 170mm) |
| ● Gross Weight | 1.32 lb (0.6Kg) |
| ● Operating Temperature | 32°F~140°F (0°C~60°C) |
| ● Storage Temperature | -4°F~158°F (-20°C~70°C) |
| ● Operating Humidity | 0% ~ 90% relative humidity, |

non-condensing

Display: Supports CRT/LCD simultaneous / dual view displays

- Chipset Intel® Core i7/i5/Celeron® + QM77 integrated Gen 5.75 graphics
- Memory Shared system memory up to 256MB
- Resolution Up to 2560x1600 @ 60 Hz for 1st DisplayPort™;
Up to 1920x1600 @ 60 Hz for 2nd DisplayPort™;
Up to 1920x1200 @ 60 Hz for VGA, DVI, HDMI
- Output Interface Dual Display Version: CRT, Dual 24-bit LVDS, DVI-D, HDMI, DisplayPort™;
Three Display Version: CRT, Dual 24-bit LVDS, DVI-D, DisplayPort™x 2

I/O: ITE IT8728F

- Storage SATA 6.0Gb/s x 2 , SATA 3.0Gb/s x 2, support RAID 0, 1, 5, 10
- Serial Port RS-232 x 1 (box header)
RS-232/422/485 x 1 (on I/O)
- USB USB2.0 x 6, USB3.0 x 4 (Dock USB w/LAN x 2)
- PS/2 Port Keyboard x 1, Mouse x 1
- Digital I/O 8-bit Programmable (4 in/ 4 out)
- Audio Line-in, Mic-in, Line-out

Chapter

2

**Quick
Installation
Guide**

2.1 Safety Precautions

Warning!

Always completely disconnect the power cord from your board whenever you are working on it. Do not make connections while the power is on, because a sudden rush of power can damage sensitive electronic components.

Caution!

Always ground yourself to remove any static charge before touching the board. Modern electronic devices are very sensitive to static electric charges. Use a grounding wrist strap at all times. Place all electronic components on a static-dissipative surface or in a static-shielded bag when they are not in the chassis

2.2 Location of Connectors and Jumpers

Component Side

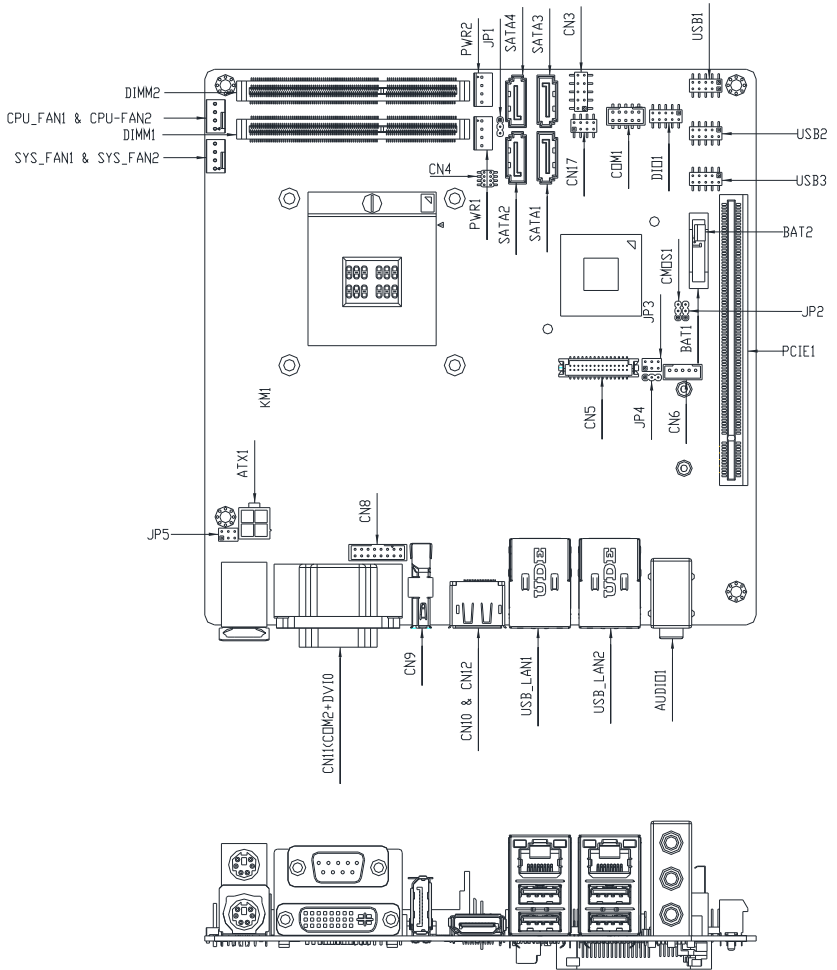

Solder Side

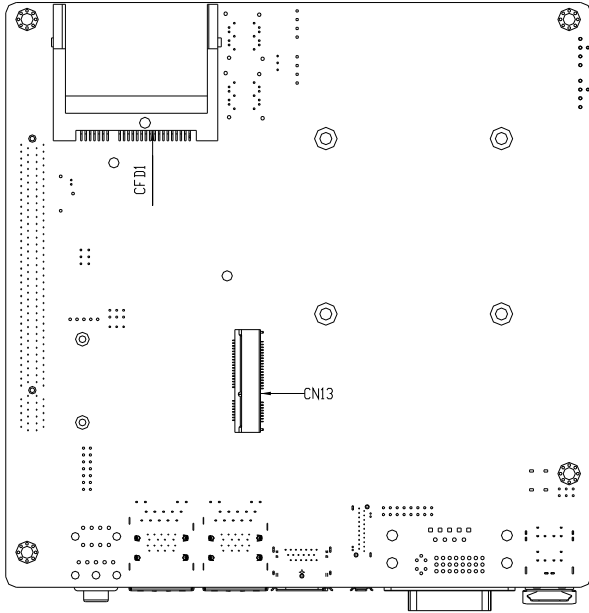

2.3 Mechanical Drawing

Component Side

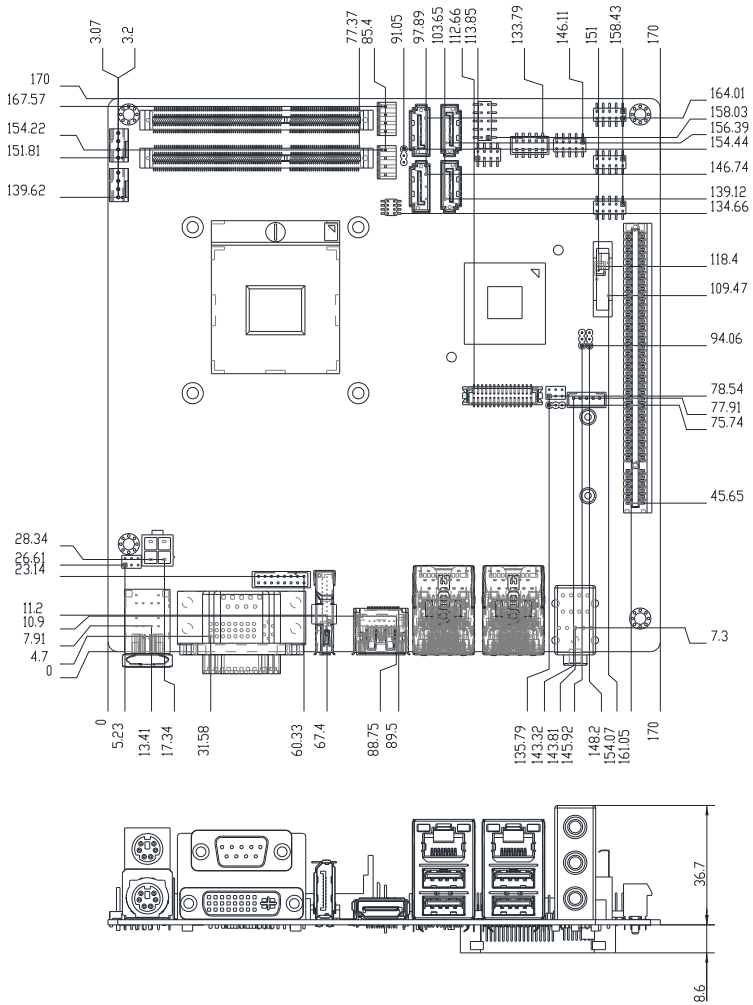

Solder Side

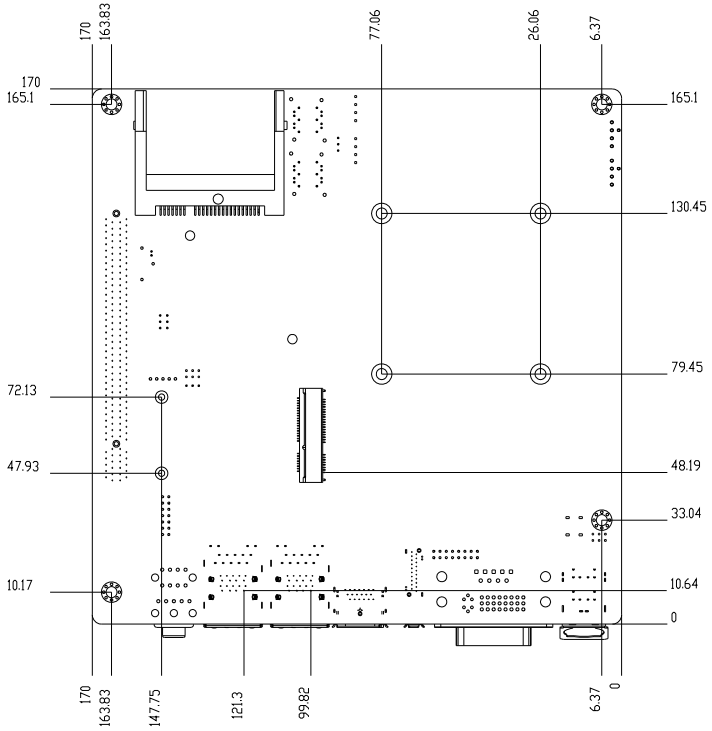

2.4 List of Jumpers

The board has a number of jumpers that allow you to configure your system to suit your application.

The table below shows the function of each of the board's jumpers:

Label	Function
CMOS1	CMOS Setting Selection
JP1	Auto Power Button
JP2	ME Setting Selection
JP3	LVDS Voltage & Inverter Voltage Selection
JP4	LVDS Backlight Brightness Control Selection
JP5	+12V/+5V/RING Selection
CN17	LVDS Analyze degree Selection

2.5 List of Connectors

The board has a number of connectors that allow you to configure your system to suit your application.

The table below shows the function of each of the board's connectors:

Label	Function
DIO1	Digital I/O
PWR1 ~ PWR2	SATA POWER
CN11	COM2 (RS-232/422/485) / DVI Connector
PCIE1	PCIE*16 Connector
CN3	Front Panel Connector
CN5	LVDS Connector

CN6	Inverter Power Connector
CN8	VGA Connector
CN9	DP2 Connector
CN10 / CN12	DP1 / HDMI Connector (co-layout)
CN13	Mini Card Connector
CN14	CFast Connector
KM1	Keyboard/Mouse Connector
COM1	RS-232 Box Header
SATA1~SATA2	SATA 3.0 Connector
SATA3~SATA4	SATA Connector
USB_LAN1 ~ USB_LAN2	LAN / USB Connector
DIMM1,DIMM2	DDR3 DIMM Slot
USB1 ~ USB3	USB Box Header
FAN1~ FAN2	4 Pin Fan Connector
AUDIO1	AUDIO Connector
ATX1	4 pin 12V DC-IN Connector

2.6 Setting Jumpers

You configure your card to match the needs of your application by setting jumpers. A jumper is the simplest kind of electric switch. It consists of two metal pins and a small metal clip (often protected by a plastic cover) that slides over the pins to connect them. To “close” a jumper you connect the pins with the clip.

To “open” a jumper you remove the clip. Sometimes a jumper will have three pins, labeled 1, 2 and 3. In this case you would connect either pins 1 and 2 or 2 and 3.

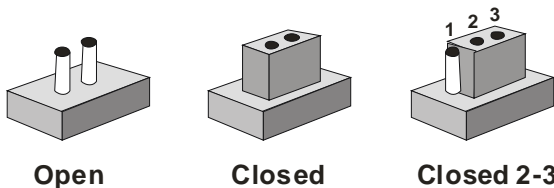

A pair of needle-nose pliers may be helpful when working with jumpers.

If you have any doubts about the best hardware configuration for your application, contact your local distributor or sales representative before you make any change.

Generally, you simply need a standard cable to make most connections.

2.7 Clear CMOS (CMOS1)

CMOS1	Function
1-2	Normal (Default)
2-3	Clear CMOS

2.8 Auto Power Button (JP1)

JP1	Function
1-2	ATX (Default)
2-3	AT

2.9 Clear ME (JP2)

JP2	Function
1-2	Save ME RTC Register (Default)
2-3	Clear ME RTC Register

2.10 LVDS & Inverter Voltage Selection (JP3)

LVDS Voltage

JP3	Function
2-4	+5V
4-6	+3.3V (Default)

Inverter Voltage

JP3	Function
1-3	+12V (Default)
3-5	+5V

2.11 LVDS Backlight Brightness Control Selection (JP4)

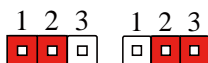

JP4	Function
1-2	PWM Clock Control
2-3	Voltage Control (Default)

2.12 +12V/+5V/RING Selection (JP5)

JP5	Function
1-2	+12V
3-4	Ring (Default)
5-6	+5V

2.13 Front Panel Connector (CN3)

Pin	Signal	Pin	Signal
1	Power On Button (-)	2	Power On Button (+)
3	HDD LED (-)	4	HDD LED (+)
5	SPEAKER(-)	6	SPEAKER(+)
7	Power LED (-)	8	Power LED (+)
9	Reset Switch (-)	10	Reset Switch (+)

2.14 LVDS Connector (CN5)

Pin	Signal	Pin	Signal
1	BKLT_EN	2	BKLT_CTRL
3	LVDSVCC	4	GND
5	LVDS1_CLK#	6	LVDS1_CLK
7	LVDSVCC	8	GND
9	LVDS1_DATA0#	10	LVDS1_DATA0
11	LVDS1_DATA1#	12	LVDS1_DATA1

Mini-ITX**EMB-QM77**

13	LVDS1_DATA2#	14	LVDS1_DATA2
15	LVDS1_DATA3#	16	LVDS1_DATA3
17	LVDS_DDC_DATA	18	LVDS_DDC_CLK
19	LVDS2_DATA0#	20	LVDS2_DATA0
21	LVDS2_DATA1#	22	LVDS2_DATA1
23	LVDS2_DATA2#	24	LVDS2_DATA2
25	LVDS2_DATA3#	26	LVDS2_DATA3
27	LVDSVCC	28	GND
29	LVDS2_CLK#	30	LVDS2_CLK

Note: The max. rating of pin3,7,27 is 2A @ 5V / 3.3V.

2.15 LVDS Inverter Power Wafer (CN6)

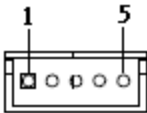

Pin	Signal
1	BKL_PWR
2	BKL_CTRL
3	GND
4	GND
5	BKL_EN

2.16 DVI-D/ COM2 Port Connector (CN11)

DVI-D Port Connector

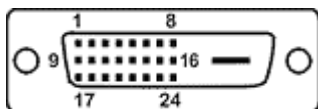

Pin	Signal	Pin	Signal
1	DATA2_N	13	N.C.
2	DATA2_P	14	+5V_DVI
3	GND	15	GND
4	N.C.	16	HPD#
5	N.C.	17	DATA0_N
6	DDC_CLK	18	DATA0_P
7	DDC_DATA	19	GND
8	N.C.	20	N.C.
9	DATA1_N	21	N.C.
10	DATA1_P	22	GND
11	GND	23	CLK_P
12	N.C.	24	CLK_N

COM2 Port Connector

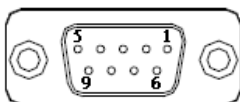

RS-232

Pin	Signal
1	DCD1
2	RXD1
3	TXD1
4	DTR1
5	GND
6	DSR1
7	RTS1
8	CTS1
9	RI1 / +5V / +12V

RS-422

Pin	Signal
1	RS422_TX-
2	RS422_RX+
3	RS422_TX+
4	RS422_RX-
5	GND
6	NC
7	NC
8	NC
9	NC / +5V / +12V

RS-485

Pin	Signal
1	RS485_D-

2	NC
3	RS485_D+
4	NC
5	GND
6	NC
7	NC
8	NC
9	NC / +5V / +12V

2.17 LVDS Analyze Degree Selection (CN17)

	PID_3 (GPIO49)	PID_2 (GPIO48)	PID_1 (GPIO39)	PID_0 (GPIO38)
Reserved	0	0	0	0
640x480	0	0	0	1
800x480	0	0	1	0
800x600	0	0	1	1
1024x768	0 (7-8)	1 (Open)	0 (3-4)	0 (1-2)
Reserved	0	1	0	1
1600x1200	0	1	1	1
1366x768	1	0	0	0
1680x1050	1	0	0	1
1920x1200	1	0	1	0
1440x900	1	0	1	1
1600x900	1	1	0	0

Reserved	1	1	0	1
1280x800	1	1	1	0
1920x1080	1	1	1	1

0 : The PID pin is low level

1 : The PID pin is high level

2.18 Digital I/O (DIO1)

This connector offers 4-pair of digital I/O functions and address is 801H. The pin definitions are illustrated below:

Pin	Signal	Pin	Signal
1	Digital- IN/OUT(Port1 Bit 1)	2	Digital- IN/OUT (Port1 Bit 2)
3	Digital- IN/OUT (Port1 Bit 4)	4	Digital- IN/OUT (Port3 Bit 4)
5	Digital- IN/OUT (Port3 Bit 5)	6	Digital- IN/OUT (Port3 Bit 6)
7	Digital- IN/OUT (Port3 Bit 7)	8	Digital- IN/OUT (Port6 Bit 3)
9	+3.3V	10	GND

The pin definitions and registers mapping are illustrated below:

Address: 801H

4 in / 4 out

Pin1	Pin2	Pin3	Pin4	Pin5	Pin6	Pin7	Pin8
GPI 11	GPI 12	GPI 14	GPI 34	GPO 35	GPO 36	GPO 37	GPO 63

8 in

Pin1	Pin2	Pin3	Pin4	Pin5	Pin6	Pin7	Pin8
GPI 11	GPI 12	GPI 14	GPI 34	GPO 35	GPO 36	GPO 37	GPO 63

8 out

Pin1	Pin2	Pin3	Pin4	Pin5	Pin6	Pin7	Pin8
GPI 11	GPI 12	GPI 14	GPI 34	GPO	GPO	GPO	GPO

				35	36	37	63
--	--	--	--	----	----	----	----

2.19 SATA Power (PWR1~PWR2)

Pin	Signal
1	+12V
2	GND
3	GND
4	+5V

2.20 RS-232 Box Header (COM 1)

Pin	Signal	Pin	Signal
1	DCD	2	RXD
3	TXD	4	DTR
5	GND	6	DSR
7	RTS	8	CTS
9	RI	10	N.C

2.21 USB Box Header (USB1 ~ USB3)

Pin	Signal	Pin	Signal
1	+5V	2	GND
3	USBD-	4	GND
5	USBD+	6	USBD+
7	GND	8	USBD-
9	GND	10	+5V

Below Table for China RoHS Requirements

产品中有毒有害物质或元素名称及含量

AAEON Main Board/ Daughter Board/ Backplane

部件名称	有毒有害物质或元素					
	铅 (Pb)	汞 (Hg)	镉 (Cd)	六价铬 (Cr(VI))	多溴联苯 (PBB)	多溴二苯醚 (PBDE)
印刷电路板 及其电子组件	×	○	○	○	○	○
外部信号 连接器及线材	×	○	○	○	○	○
<p>O: 表示该有毒有害物质在该部件所有均质材料中的含量均在 SJ/T 11363-2006 标准规定的限量要求以下。</p> <p>X: 表示该有毒有害物质至少在该部件的某一均质材料中的含量超出 SJ/T 11363-2006 标准规定的限量要求。</p> <p>备注：此产品所标示之环保使用期限，系指在一般正常使用状况下。</p>						

Chapter

3

**AMI
BIOS Setup**

3.1 System Test and Initialization

These routines test and initialize board hardware. If the routines encounter an error during the tests, you will either hear a few short beeps or see an error message on the screen. There are two kinds of errors: fatal and non-fatal. The system can usually continue the boot up sequence with non-fatal errors.

System configuration verification

These routines check the current system configuration stored in the CMOS memory and BIOS NVRAM. If system configuration is not found or system configuration data error is detected, system will load optimized default and re-boot with this default system configuration automatically.

There are four situations in which you will need to setup system configuration:

1. You are starting your system for the first time
2. You have changed the hardware attached to your system
3. The system configuration is reset by Clear-CMOS jumper
4. The CMOS memory has lost power and the configuration information has been erased.

The EMB-QM77 CMOS memory has an integral lithium battery backup for data retention. However, you will need to replace the battery when it finally runs down.

3.2 AMI BIOS Setup

AMI BIOS ROM has a built-in Setup program that allows users to modify the basic system configuration. This type of information is stored in battery-backed CMOS RAM so that it retains the Setup information when the power is turned off.

Entering Setup

Power on the computer and press or <F2> immediately. This will allow you to enter Setup.

Main

Set the date, use tab to switch between date elements.

Advanced

Advanced BIOS Features Setup including TPM, ACPI, etc.

Chipset

Host bridge parameters.

Boot

Enables/disable quiet boot option.

Security

Set setup administrator password.

Save&Exit

Exit system setup after saving the changes.

Setup Menu

Setup submenu: Main

Aptio Setup Utility - Copyright (C) 2011 American Megatrends, Inc.	
Main Advanced Chipset Boot Security Save & Exit	
BIOS Information EMB-QM77 R2.4(EM77AM24) (04/16/2013)	Set the Date. Use Tab to switch between Date elements.
BIOS Vendor Core Version Compliance	American Megatrends 4.6.5.3 x64 UEFI 2.3; PI 1.2
System Date System Time	[Tue 04/16/2013] [21:20:43]
Access Level	Administrator
	++: Select Screen ↑↓: Select Item Enter: Select +/-: Change Opt. F1: General Help F2: Previous Values F3: Optimized Defaults F4: Save & Exit ESC: Exit
Version 2.14.1219. Copyright (C) 2011 American Megatrends, Inc.	

Setup submenu: Advanced

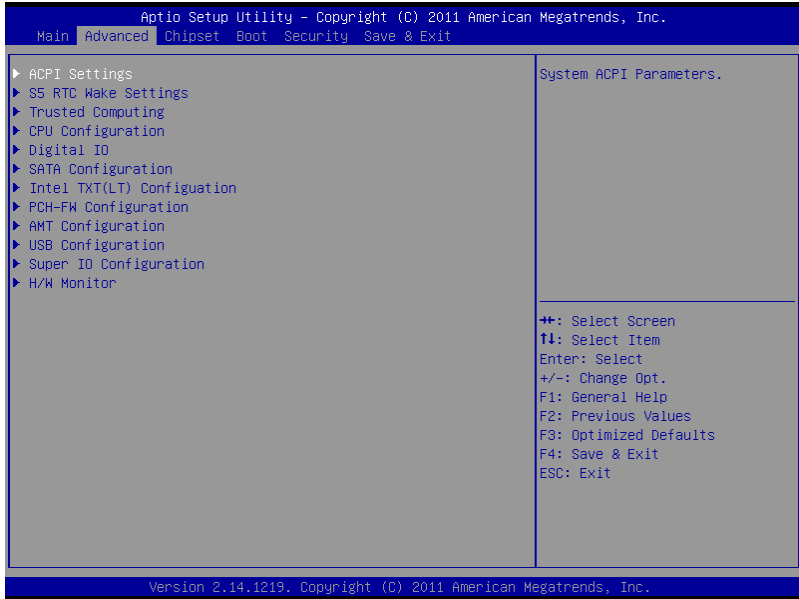

ACPI Settings

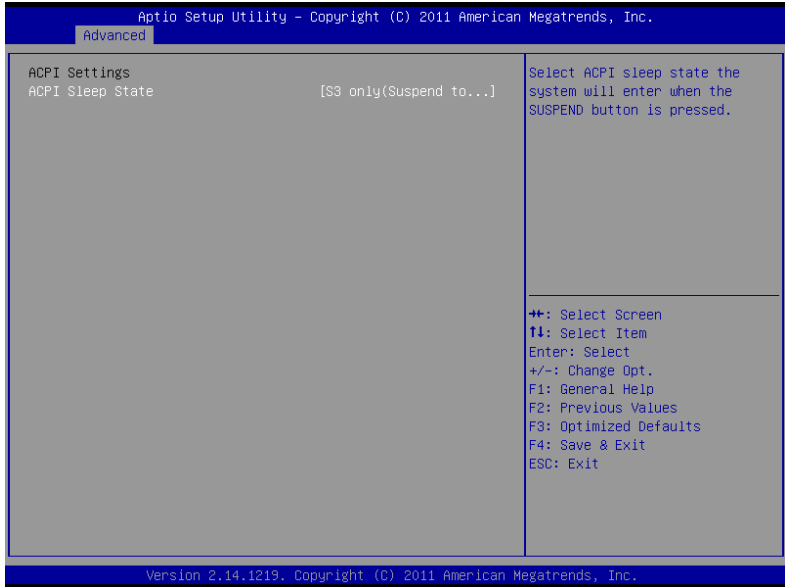

Options Summary :

ACPI Sleep State	S1 Only (CPU Stop Clock)	
	S3 Only (Suspend to RAM)	Default
Select ACPI sleep state the system will enter when the SUSPEND button is pressed.		

S5 RTC Wake Settings

Aptio Setup Utility - Copyright (C) 2011 American Megatrends, Inc.

Advanced

Wake system with Fixed Time	[Enabled]	Enable or disable System wake on alarm event. When enabled, System will wake on the hr::min::sec specified
Wake up day	0	
Wake up hour	0	
Wake up minute	0	
Wake up second	0	
Wake system with Dynamic Time	[Disabled]	

+/-: Select Screen
 T1: Select Item
 Enter: Select
 +/-: Change Opt.
 F1: General Help
 F2: Previous Values
 F3: Optimized Defaults
 F4: Save & Exit
 ESC: Exit

Version 2.14.1219. Copyright (C) 2011 American Megatrends, Inc.

Options Summary :

Wake system with	Disabled	Default
Fixed Time	Enabled	
Enable or disable System wake on alarm event. When enabled, System will wake on the hr::min::sec specified.		
Wake system with	Disabled	Default
Dynamic Time	Enabled	
Enable or disable System wake on alarm event. When enabled, System will wake on the current time + Increase minute(s).		

Trusted Computing

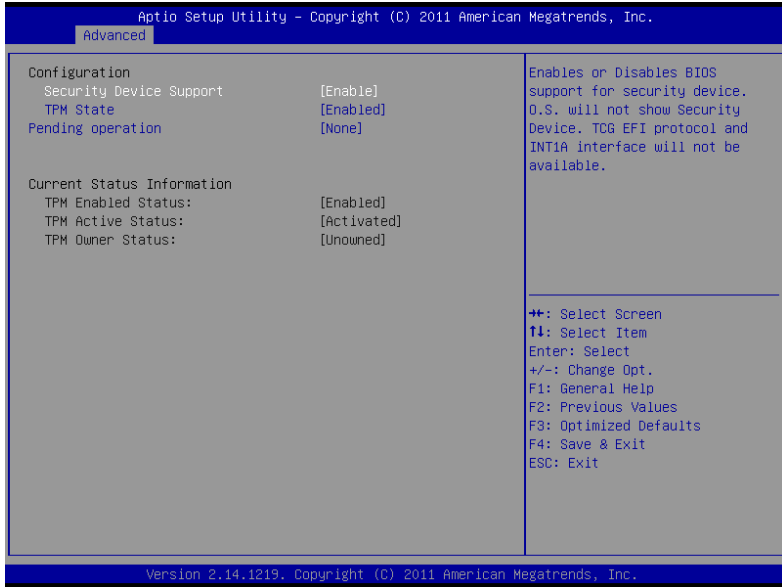

Options Summary :

Security Device Support	Disable	Default
	Enable	
Enable or Disable BIOS support for security device. O.S. will not show Security Device. TCG EFI protocol and INT1A interface will not be available.		
TPM State	Disabled	Default
	Enabled	

Enable/Disable Security Device.

Note: Your Computer will reboot during restart in order to change State of the Device.

Pending operation	None	Default
	Enable Take Ownership	
	Disable Take Ownership	
	TPM Clear	

Schedule an Operation for the Security Device.

Note: Your Computer will reboot during restart in order to change State of the Device.

CPU Configuration

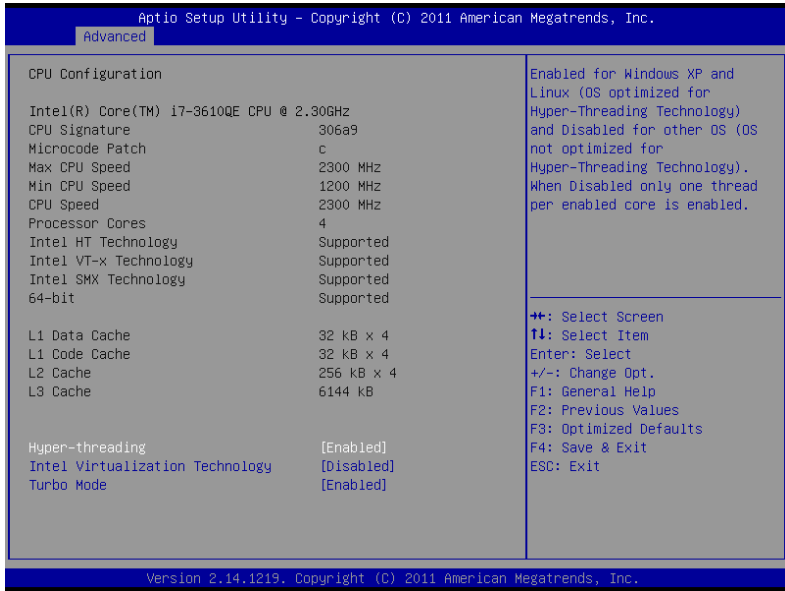

Options Summary :

Hyper-Threading	Disabled	
	Enabled	Default
<p>Enabled for Windows XP and Linux (OS optimized for Hyper-Threading Technology) and Disabled for other OS (OS not optimized for Hyper-Threading Technology).</p> <p>When Disabled only one thread per enabled core is enabled.</p>		
Intel Virtualization Technology	Disabled	Default
	Enabled	

When enabled, a VMM can utilize the additional hardware capabilities provided by Vanderpool Technology

Turbo Mode	Disabled	Failsafe Default
	Enabled	Optimal Default

For En/Disabled CPU Turbo Mode feature

Digital IO

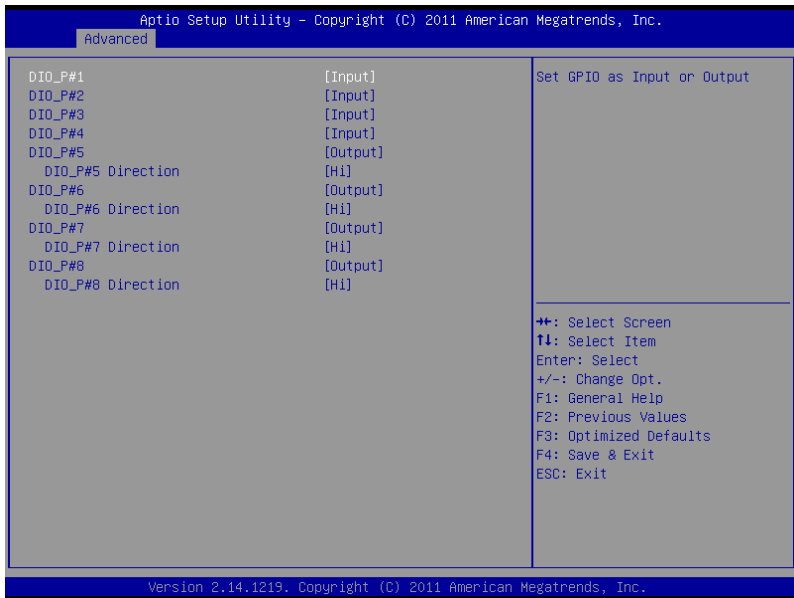

Options Summary :

DIO_P#1	Input	Default
		Output

Set Digital IO as Input or Output

DIO_P#1 Direction	Low	Default
	Hi	
Set Digital IO Level as Low or Hi		
DIO_P#2	Input	Default
	Output	
Set Digital IO as Input or Output		
DIO_P#2 Direction	Low	Default
	Hi	
Set Digital IO Level as Low or Hi		
DIO_P#3	Input	Default
	Output	
Set Digital IO as Input or Output		
DIO_P#3 Direction	Low	Default
	Hi	
Set Digital IO Level as Low or Hi		
DIO_P#4	Input	Default
	Output	
Set Digital IO as Input or Output		
DIO_P#4 Direction	Low	Default
	Hi	
Set Digital IO Level as Low or Hi		
DIO_P#5	Input	
	Output	Default
Set Digital IO as Input or Output		

DIO_P#5 Direction	Low	
	Hi	Default
Set Digital IO Level as Low or Hi		
DIO_P#6	Input	
	Output	Default
Set Digital IO as Input or Output		
DIO_P#6 Direction	Low	
	Hi	Default
Set Digital IO Level as Low or Hi		
DIO_P#7	Input	
	Output	Default
Set Digital IO as Input or Output		
DIO_P#7 Direction	Low	
	Hi	Default
Set Digital IO Level as Low or Hi		
DIO_P#8	Input	
	Output	Default
Set Digital IO as Input or Output		
DIO_P#8 Direction	Low	
	Hi	Default
Set Digital IO Level as Low or Hi		

SATA Configuration (IDE)

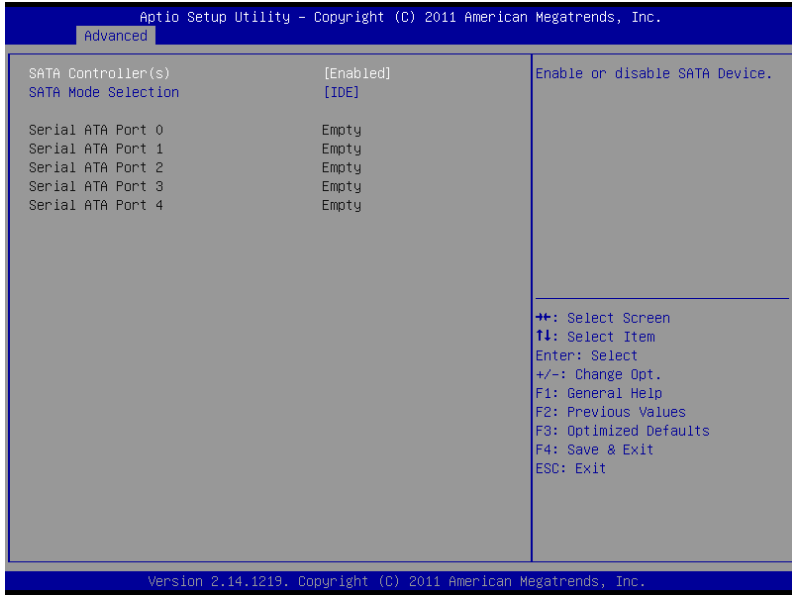

Options summary :

SATA Controller(s)	Enabled	Default
	Disabled	
Enable or disable SATA device.		
SATA Mode Selection	IDE	Default
	AHCI	
	RAID	
Determines how SATA controller(s) operate.		

SATA Configuration (AHCI)

Aptio Setup Utility - Copyright (C) 2011 American Megatrends, Inc.		
Advanced		
SATA Controller(s)	[Enabled]	Enable or disable SATA Device.
SATA Mode Selection	[AHCI]	
Serial ATA Port 0	Empty	
Port 0	[Enabled]	
Hot Plug	[Disabled]	
Serial ATA Port 1	Empty	
Port 1	[Enabled]	
Hot Plug	[Disabled]	
Serial ATA Port 2	Empty	
Port 2	[Enabled]	
Hot Plug	[Disabled]	
Serial ATA Port 3	Empty	
Port 3	[Enabled]	++: Select Screen
Hot Plug	[Disabled]	↑↓: Select Item
Serial ATA Port 4	Empty	Enter: Select
Port 4	[Enabled]	+/-: Change Opt.
Hot Plug	[Disabled]	F1: General Help
		F2: Previous Values
		F3: Optimized Defaults
		F4: Save & Exit
		ESC: Exit

Version 2.14.1219, Copyright (C) 2011 American Megatrends, Inc.

SATA Configuration (RAID)

Aptio Setup Utility - Copyright (C) 2011 American Megatrends, Inc.		
Advanced		
SATA Controller(s)	[Enabled]	Determines how SATA controller(s) operate.
SATA Mode Selection	[RAID]	
Serial ATA Port 0	Empty	⇄: Select Screen ↑↓: Select Item Enter: Select +/-: Change Opt. F1: General Help F2: Previous Values F3: Optimized Defaults F4: Save & Exit ESC: Exit
Port 0	[Enabled]	
Hot Plug	[Disabled]	
Serial ATA Port 1	Empty	
Port 1	[Enabled]	
Hot Plug	[Disabled]	
Serial ATA Port 2	Empty	
Port 2	[Enabled]	
Hot Plug	[Disabled]	
Serial ATA Port 3	Empty	
Port 3	[Enabled]	
Hot Plug	[Disabled]	
Serial ATA Port 4	Empty	
Port 4	[Enabled]	
Hot Plug	[Disabled]	

Version 2.14.1219. Copyright (C) 2011 American Megatrends, Inc.

Intel TXT(LT) Configuration

Aptio Setup Utility - Copyright (C) 2011 American Megatrends, Inc.

Advanced

Intel Trusted Execution Technology Configuration

Intel TXT support only can be enabled/disabled if SMX is enabled. VT and VT-d support must also be enabled prior to TXT.

Secure Mode Extensions (SMX)	Enabled
Intel TXT(LT) Support	[Disabled]

++: Select Screen
t1: Select Item
Enter: Select
+/-: Change Opt.
F1: General Help
F2: Previous Values
F3: Optimized Defaults
F4: Save & Exit
ESC: Exit

Version 2.14.1219. Copyright (C) 2011 American Megatrends, Inc.

PCH-FW Configuration

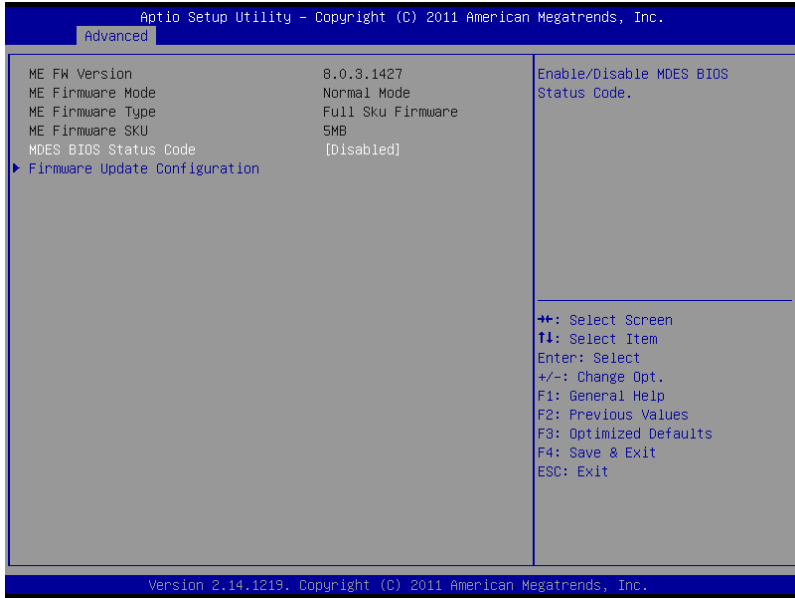

Options summary :

MDES BIOS Status Code	Disabled	Default
	Enabled	
Enable/Disable MDES BIOS Status Code.		
Me FW Image Re-Flash	Disabled	Default
	Enabled	
Enable/Disable Me FW Image Re-Flash function.		

AMT Configuration

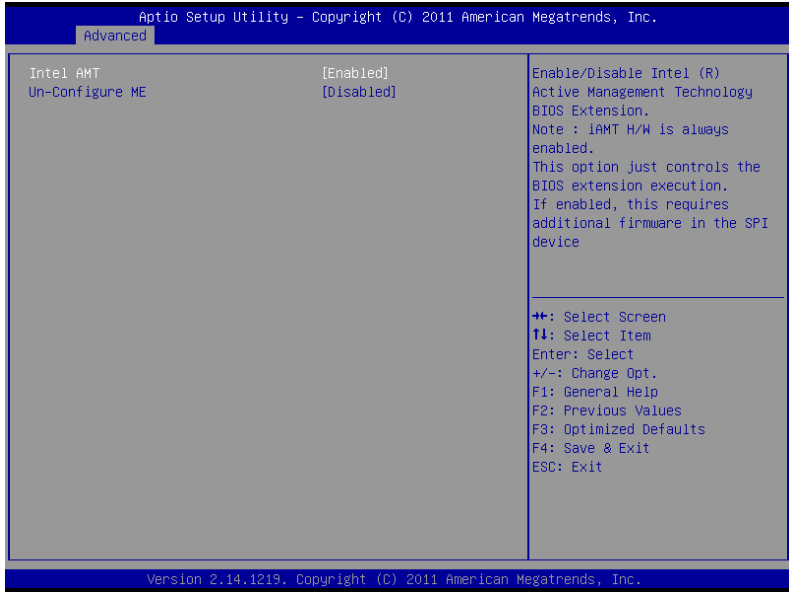

Options summary :

Intel AMT	Disabled	
	Enabled	Default
Enable/Disable Intel ® Active Management Technology BIOS Extension. Active Management Technology BIOS Extension. Note : iAMT H/W is always enabled. This option just controls the BIOS extension execution. If enabled, this requires additional firmware in the SPI device.		
Un-Configure ME	Disabled	Default
	Enabled	
OEMFlag Bit 15: Un-Configure ME without password.		

USB Configuration



Options summary :

Legacy USB Support	Enabled	Default
	Disabled	
	Auto	
Enable Legacy USB support. Auto option disables legacy support if no USB devices are connected. DISABLE option will keep USB devices available only for EFI applications.		
xHCI Mode	Disabled	
	Enabled	Default
Mode of operation of xHCI controller.		

Super IO Configuration

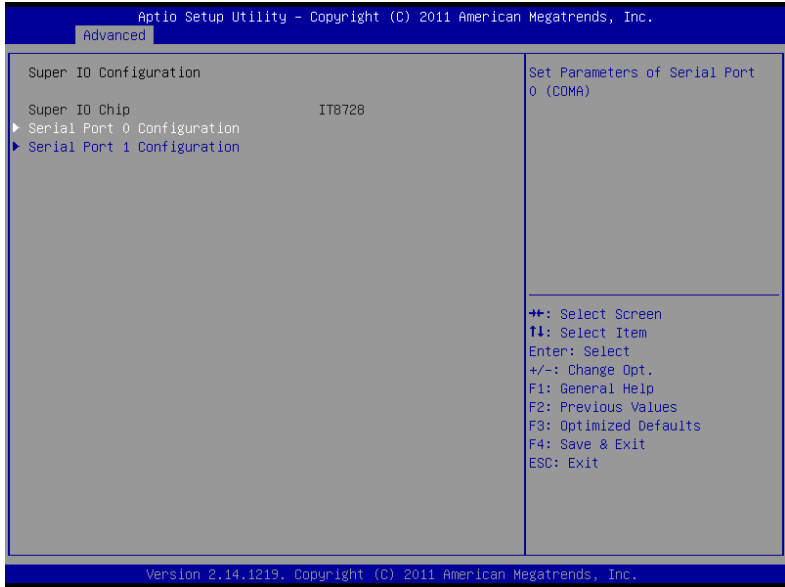

Options Summary :

Serial Port 1 Configuration	Set Parameters of Serial Port 1 (COMA)
Serial Port 2 Configuration	Set Parameters of Serial Port 2 (COMB)

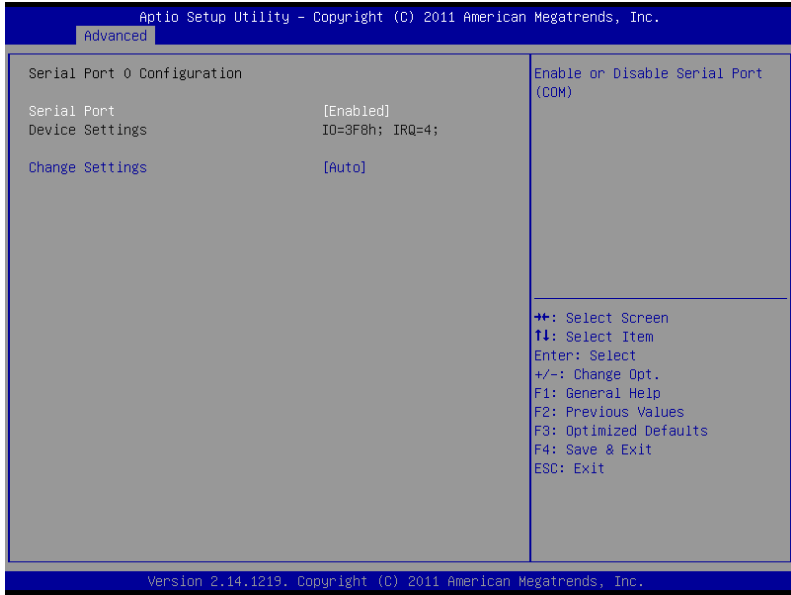
-Serial Port 1 Configuration**Options Summary :**

Serial Port	Disabled	
	Enabled	Default
Enable or Disable Serial Port (COM)		
Change Settings	Auto	Default
	IO=3F8h; IRQ=3, 4	
	IO=2F8h; IRQ=3, 4	
	IO=3E8h; IRQ=3, 4	
	IO=2E8h; IRQ=3, 4	
Select an optimal setting for Super IO device.		

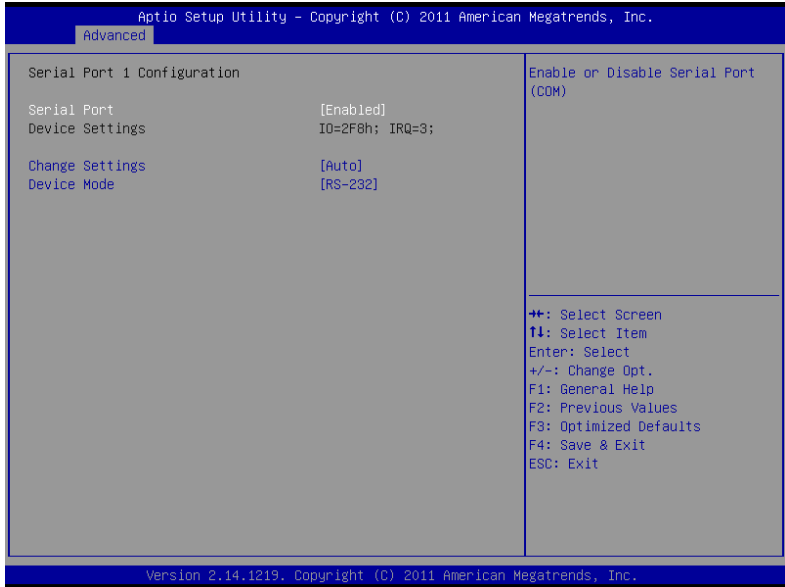
-Serial Port 2 Configuration**Options Summary :**

Serial Port	Disabled	
	Enabled	Default
Enable or Disable Serial Port (COM)		
Change Settings	Auto	Default
	IO=3F8h; IRQ=3, 4	
	IO=2F8h; IRQ=3, 4	
	IO=3E8h; IRQ=3, 4	
	IO=2E8h; IRQ=3, 4	
Select an optimal setting for Super IO device.		

Device Mode	RS-232	Default
	RS-422	
	RS-485	
Change the Serial Port mode. Select <RS-232> or <RS-422> or <RS-485> mode.		

H/W Monitor

Aptio Setup Utility - Copyright (C) 2011 American Megatrends, Inc.

Advanced

Pc Health Status		For En/Disable CPU Fan1 Control Enabled: Fan is running in accordance with user settings Disabled: Fan is always running with full speed
CPU Fan1 Control	[Enabled]	
Fan Control Mode	[Manual Mode]	
PHM Duty	200	
SYS Fan1 Control	[Enabled]	
Fan Control Mode	[Automatic Mode]	
Spin PHM	100	
Off Control Temperature	30	
Start Control Temperature	50	
Full Speed Temperature	80	
PHM Slope	5	
Hysteresis Temperature	0	
CPU Temperature	: +45 C	
PCH Temperature	: +36 C	
System Temperature	: +29 C	
CPU Fan1 Speed	: 4623 RPM	
SYS Fan1 Speed	: N/A	
VCORE	: +0.960 V	
+V1.5S	: +1.500 V	
+V3.3S	: +3.336 V	
+V5S	: +5.040 V	
+V12S	: +11.904 V	
VBAT	: +3.000 V	
		++: Select Screen ↑: Select Item Enter: Select +/-: Change Opt. F1: General Help F2: Previous Values F3: Optimized Defaults F4: Save & Exit ESC: Exit

Version 2.14.1219. Copyright (C) 2011 American Megatrends, Inc.

Options Summary :

CPU Fan1 Control	Disabled	Default
	Enabled	

For En/Disable CPU Fan1 Control

Enabled : Fan is running in accordance with user settings

Disabled : Fan is always running with full speed

Fan Control Mode	Manual Mode	Default
	Automatic Mode	

Manual Mode : Depends on PWM Duty

Automatic Mode : Fan Speed is depends on CPU Temperature

PWM Duty	Default 200
----------	-------------

Manual Mode PWM Duty value Range:[0 - 255]

Spin PWM	Default 100
----------	-------------

The PWM Duty of Fan Spin

Off Control Temperature	Default 30
-------------------------	------------

Temperature Limit Value of Fan Off

Note: Some fans have the minimum speed even if the PWM value is 0

Start Control Temperature	Default 50
---------------------------	------------

Temperature Limit Value of Fan Start Control

Full Speed Temperature	Default 80
------------------------	------------

Temperature Limit Value of Fan Full Speed

PWM Slope	Default 5
-----------	-----------

Slope PWM value/Degree C for Fan Speed Control

Range: [1 – 15]

Hysteresis Temperature	Default 0
------------------------	-----------

Set the Hysteresis Temperature value.

Range: [0 – 31]

Setup submenu: Chipset

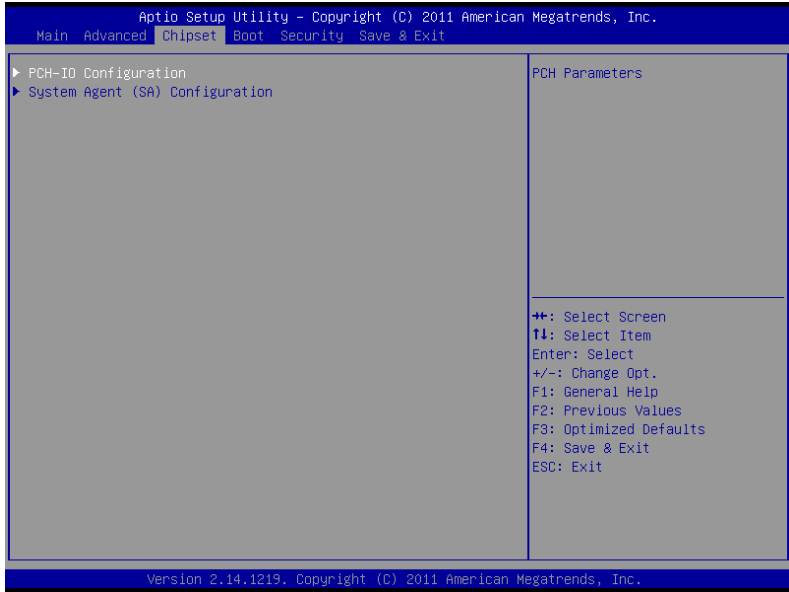

Options Summary :

PCH-IO Configuration	PCH Parameters
System Agent (SA) Configuration	System Agent (SA) Parameters

PCH-IO Configuration

Aptio Setup Utility - Copyright (C) 2011 American Megatrends, Inc.

Chipset

PCH-IO Configuration		Select Power Supply Mode.
Power Mode	[ATX Type]	
Restore AC Power Loss	[Last State]	
PCH LAN Controller	[Enabled]	
Wake on LAN	[Enabled]	
Deep S5	[Disabled]	
Mini PCIe Speed	[Gen2]	
		++: Select Screen T1: Select Item Enter: Select +/-: Change Opt. F1: General Help F2: Previous Values F3: Optimized Defaults F4: Save & Exit ESC: Exit

Version 2.14.1219. Copyright (C) 2011 American Megatrends, Inc.

Options Summary :

Power Mode	ATX Type	Default
	AT Type	
Select power supply mode.		
Restore AC Power Loss	Power Off	
	Power On	
	Last State	Default

Select AC power state when power is re-applied after a power failure.

Notice:

The system will power up after restore AC power if this item set to last state and shuts down via iAMT remote control.

PCH LAN Controller	Enabled	Default
	Disabled	

Enable or disable onboard NIC.

Wake on LAN	Enabled	Default
	Disabled	

Enable or disable integrated LAN to wake the system. (The Wake On LAN cannot be disabled if ME is on at Sx state.)

Deep S5	Disabled	Default
	Enabled	

Enabled/Disabled Deep S5.

Note : When Deep S5 is enabled, Intel® AMT and Wake On PCH LAN functions are not available in system shut down.

Mini PCIe Speed	Gen1	
	Gen2	Default

Select Mini PCI Express port speed.

System Agent (SA) Configuration

Aptio Setup Utility - Copyright (C) 2011 American Megatrends, Inc.

Chipset

VT-d Capability	Supported	To enable or disable the PEG.
Memory Frequency	1067 Mhz	
Total Memory	4096 MB (DDR3)	
DIMM#0	4096 MB (DDR3)	
DIMM#2	Not Present	
VT-d	[Enabled]	
Enable PEG	[Auto]	
PEG0 - Gen X	[Auto]	
▶ Graphics Configuration		
++: Select Screen T1: Select Item Enter: Select +/-: Change Opt. F1: General Help F2: Previous Values F3: Optimized Defaults F4: Save & Exit ESC: Exit		

Version 2.14.1219. Copyright (C) 2011 American Megatrends, Inc.

Options Summary :

VT-d	Disabled	
	Enabled	Default
Check to enable VT-d function on MCH.		
Enable PEG	Disabled	
	Enabled	
	Auto	Default
To enable or disable the PEG.		
PEG0 - Gen X	Auto	Default
	Gen1	

	Gen2	
	Gen3	
Configure PEG0 B0:D1:F0 Gen1-Gen3.		

-Graphics Configuration

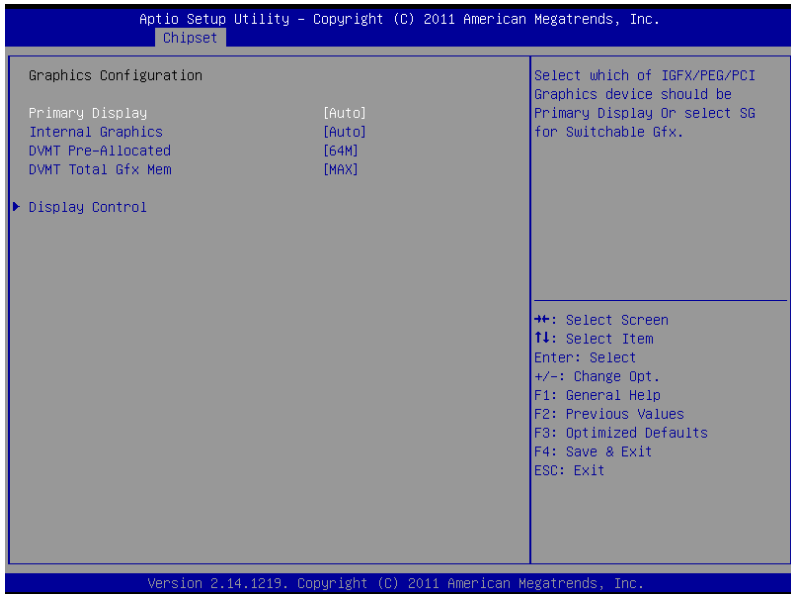

Options Summary :

Primary Display	Auto	Default
	IGFX	
	PEG	
Select which of IGFX/PEG/PCI Graphics device should be Primary Display Or select SG for Switchable Gfx.		

Internal Graphics	Auto	Default
	Disabled	
	Enabled	
Keep IGD enabled based on the setup options.		
DVMT Pre-Allocated	32M	
	64M	Default
	96M	
	128M	
	160M	
	192M	
	224M	
	256M	
	288M	
	320M	
	352M	
	384M	
	416M	
	448M	
	480M	
512M		
1024M		
Select DVMT 5.0 Pre-Allocated (Fixed) Graphics Memory size used by the Internal Graphics Device.		
DVMT Total Gfx Mem	128M	

	256M	
	MAX	Default
Select DVMT5.0 Total Graphic Memory size used by the Internal Graphics Device.		

-Display Control

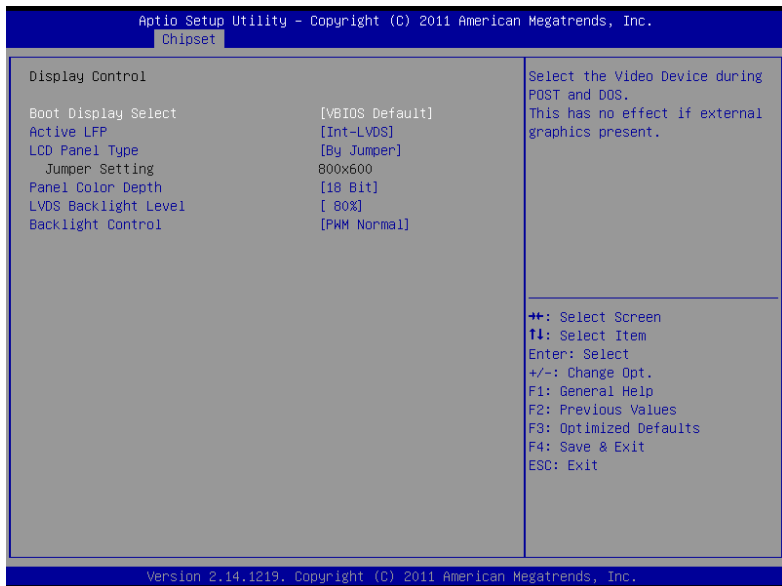

Options Summary :

Boot Display Select	VBIOS Default	Default
	CRT	
	DisplayPort 1 / HDMI	

	LVDS	
	DVI	
	DisplayPort 2 / DisplayPort	
	CRT+LVDS	
<p>Select the Video Device during POST and DOS. This has no effect if external graphics present.</p>		
Active LFP	No LVDS	
	Int-LVDS	Default
<p>Select the Active LFP Configuration. No LVDS:VBIOS does not enable LVDS. Int-LVDS:VBIOS enables LVDS driver by Integrated encoder.</p>		
LCD Panel Type	By Jumper	Default
	640x480	
	800x480	
	800x600	
	1024x768	
	1280x1024	
	1600x1200	
	1366x768	
	1680x1050	
	1920x1200	
	1440x900	
	1600x900	

	1280x800	
	1920x1080	
Select LCD panel used by Internal Graphics Device by selecting the appropriate setup item.		
Panel Color Depth	18 Bit	Default
	24 Bit	
Select the LFP Panel Color Depth		
LVDS Backlight Level	100%	
	90%	
	80%	Default
	70%	
	60%	
	50%	
	40%	
	30%	
	20%	
	10%	
	0%	
Select Backlight brightness of LVDS		
Backlight Control	PWM Inverted	
	PWM Normal	Default
Back Light Control Setting		

Setup submenu: Boot

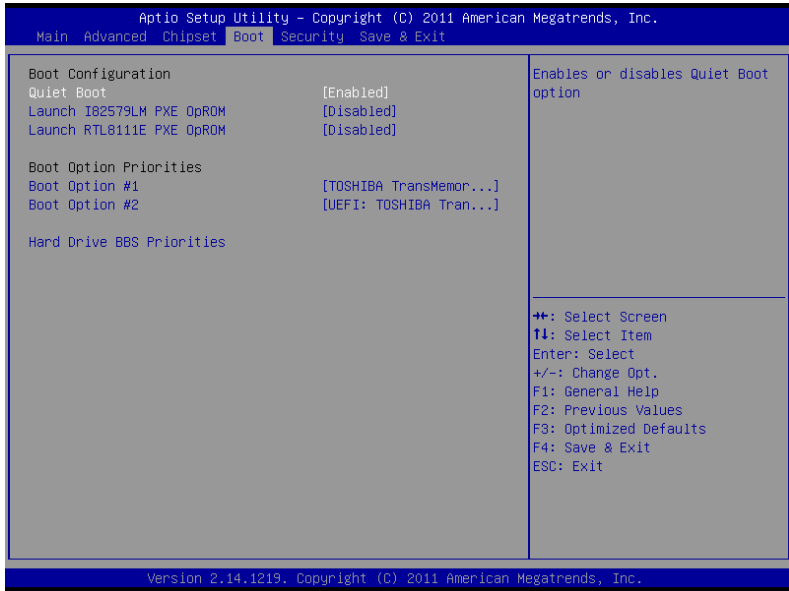

Options summary :

Quiet Boot	Disabled	
	Enabled	Default
Enables or disables Quiet Boot option		
Launch I82579LM PXE OpROM	Disabled	Default
	Enabled	
En/Disable PXE boot for I82579LM LAN		
Launch RTL8111E PXE OpROM	Disabled	Default
	Enabled	
En/Disable PXE boot for RTL8111E LAN		

Boot Option Priorities

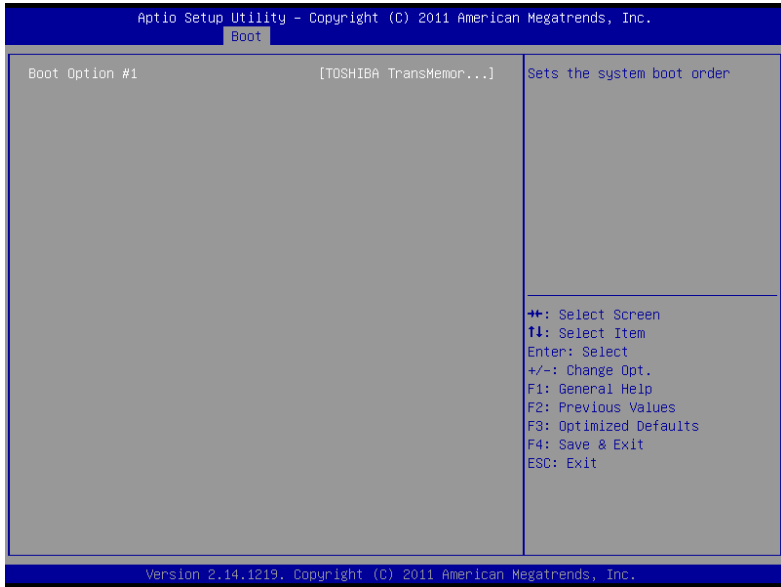

Options Summary :

Boot Option #X	Your device	
	Your device	
Sets the system boot order		

Setup submenu: Security

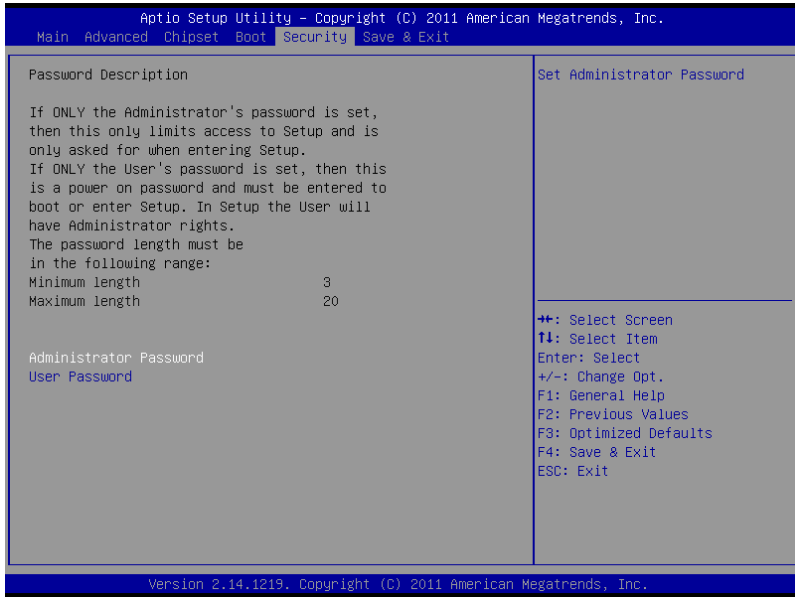

Change User/Supervisor Password

You can install a Supervisor password, and if you install a supervisor password, you can then install a user password. A user password does not provide access to many of the features in the Setup utility.

If you highlight these items and press Enter, a dialog box appears which lets you enter a password. You can enter no more than six letters or numbers. Press Enter after you have typed in the password. A second dialog box asks you to retype the password for confirmation. Press Enter after you have retyped it correctly. The password is required at boot time, or when the user enters the

Setup utility.

Removing the Password

Highlight this item and type in the current password. At the next dialog box press Enter to disable password protection.

Setup submenu: Exit

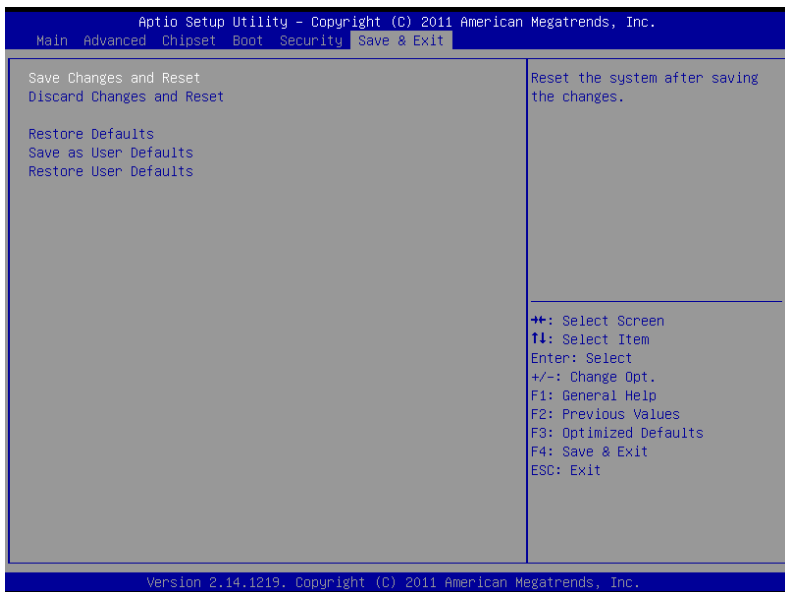

Chapter

4

**Driver
Installation**

The EMB-QM77 comes with an AutoRun DVD-ROM that contains all drivers and utilities that can help you to install the driver automatically.

Insert the driver DVD, the driver DVD-title will auto start and show the installation guide. If not, please follow the sequence below to install the drivers.

Follow the sequence below to install the drivers:

- Step 1 – Install Chipset Driver
- Step 2 – Install VGA Driver
- Step 3 – Install LAN Driver
- Step 4 – Install Audio Driver
- Step 5 – Install USB3.0 Driver
- Step 6 – Install RAID & AHCI Driver
- Step 7 – Install ME Driver

Please read instructions below for further detailed installations.

4.1 Installation:

Insert the EMB-QM77 DVD-ROM into the DVD-ROM drive. And install the drivers from Step 1 to Step 7 in order.

Step 1 – Install Chipset Driver

1. Click on the **Step 1-Chipset** folder and double click on the ***infinst_autol.exe*** file
2. Follow the instructions that the window shows
3. The system will help you install the driver automatically

Step 2 – Install VGA Driver

1. Click on the **Step 2-VGA** folder and select the OS folder your system is
2. Double click on the **Setup.exe** file located in each OS folder
3. Follow the instructions that the window shows
4. The system will help you install the driver automatically

Step 3 –Install LAN Driver

1. Click on the **Step 3-LAN** folder and select the folder of LAN chip the system adopted
2. Select the OS folder your system is and double click on the **.exe** file located in each OS folder
3. Follow the instructions that the window shows
4. The system will help you install the driver automatically

Step 4 – Install Audio Driver

1. Click on the **Step 4- Audio** folder and select the OS folder your system is
2. Double click on the **.exe** located in each OS folder
3. Follow the instructions that the window shows
4. The system will help you install the driver automatically

Step 5 – Install USB3.0 Driver

1. Click on the **Step 5-USB3.0** folder and double click on the **Setup.exe** file
2. Follow the instructions that the window shows
3. The system will help you install the driver automatically

Step 6 – Install RAID & AHCI Driver

Please refer to the **Appendix D RAID & AHCI Settings**

Step 7 – Install ME Driver

1. Click on the **Step 7-ME** folder and double click on the **setup.exe** file
2. Follow the instructions that the window shows
3. The system will help you install the driver automatically

Appendix

A

Programming the Watchdog Timer

A.1 Programming

EMB-QM77 utilizes ITE IT8728 chipset as its watchdog timer controller.

Below are the procedures to complete its configuration and the AAeon initial watchdog timer program is also attached based on which you can develop customized program to fit your application.

Configuring Sequence Description

After the hardware reset or power-on reset, the ITE 8728 enters the normal mode with all logical devices disabled except KBC. The initial state (enable bit) of this logical device (KBC) is determined by the state of pin 121 (DTR1#) at the falling edge of the system reset during power-on reset.

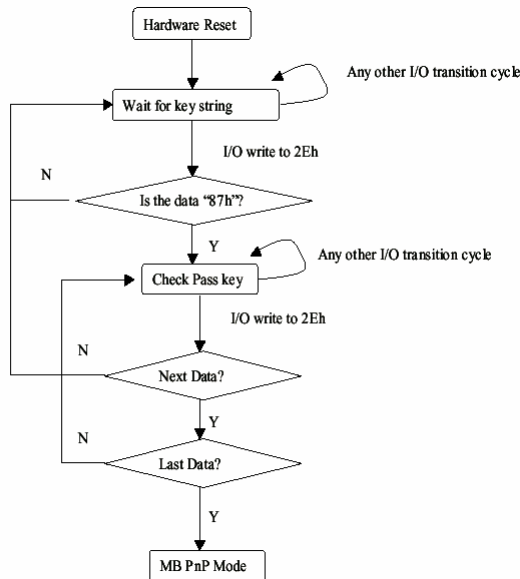

There are three steps to complete the configuration setup: (1) Enter the MB PnP Mode; (2) Modify the data of configuration registers; (3) Exit the MB PnP Mode. Undesired result may occur if the MB PnP Mode is not exited normally.

(1) Enter the MB PnP Mode

To enter the MB PnP Mode, four special I/O write operations are to be performed during Wait for Key state. To ensure the initial state of the key-check logic, it is necessary to perform four write operations to the Special Address port (2EH). Two different enter keys are provided to select configuration ports (2Eh/2Fh) of the next step.

	Address Port	Data Port
87h, 01h, 55h, 55h:	2Eh	2Fh

(2) Modify the Data of the Registers

All configuration registers can be accessed after entering the MB PnP Mode. Before accessing a selected register, the content of Index 07h must be changed to the LDN to which the register belongs, except some Global registers.

(3) Exit the MB PnP Mode

Set bit 1 of the configure control register (Index=02h) to 1 to exit the MB PnP Mode.

WatchDog Timer Configuration Registers

LDN	Index	R/W	Reset	Configuration Register or Action
All	02H	W	N/A	Configure Control
07H	71H	R/W	00H	WatchDog Timer Control Register
07H	72H	R/W	00H	WatchDog Timer Configuration Register
07H	73H	R/W	00H	WatchDog Timer Time-out Value Register

Configure Control (Index=02h)

This register is write only. Its values are not sticky; that is to say, a hardware reset will automatically clear the bits, and does not require the software to clear them.

Bit	Description
7-2	Reserved
1	Returns to the Wait for Key state. This bit is used when the configuration sequence is completed
0	Resets all logical devices and restores configuration registers to their power-on states.

WatchDog Timer Control Register (Index=71h, Default=00h)

Bit	Description
7	WDT is reset upon a CIR interrupt
6	WDT is reset upon a KBC (mouse) interrupt
5	WDT is reset upon a KBC (keyboard) interrupt
4	WDT is reset upon a read or a write to the Game Port base address
3-2	Reserved
1	Force Time-out. This bit is self-clearing
0	WDT Status
	1: WDT value reaches 0.
	0: WDT value is not 0

WatchDog Timer Configuration Register (Index=72h, Default=00h)

Bit	Description
7	WDT Time-out value select
	1: Second
	0: Minute
6	WDT output through KRST (pulse) enable
5-4	Reserved
3-0	Select the interrupt level ^{Note} for WDT

WatchDog Timer Time-out Value Register (Index=73h, Default=00h)

Bit	Description
7-0	WDT Time-out value 7-0

A.2 ITE8728 Watchdog Timer Initial Program

```
.MODEL SMALL
```

```
.CODE
```

Main:

```
CALL Enter_Configuration_mode
```

```
CALL Check_Chip
```

```
mov cl, 7
```

```
call Set_Logic_Device
```

```
;time setting
```

```
mov cl, 10 ; 10 Sec
```

```
dec al
```

Watch_Dog_Setting:

```
;Timer setting
```

```
mov al, cl
```

```
mov cl, 73h
```

```
call Superio_Set_Reg
```

```
;Clear by keyboard or mouse interrupt
```

```
mov al, 0f0h
```

```
mov cl, 71h
```

```
call Superio_Set_Reg
```

```
;unit is second.
```

```
mov al, 0C0H
```

```
mov cl, 72h
```

```
call Superio_Set_Reg
```

```
; game port enable  
mov cl, 9  
call Set_Logic_Device
```

```
Initial_OK:  
CALL Exit_Configuration_mode  
MOV AH,4Ch  
INT 21h
```

```
Enter_Configuration_Mode PROC NEAR  
MOV SI,WORD PTR CS:[Offset Cfg_Port]
```

```
MOV DX,02Eh  
MOV CX,04h  
Init_1:  
MOV AL,BYTE PTR CS:[SI]  
OUT DX,AL  
INC SI  
LOOP Init_1  
RET  
Enter_Configuration_Mode ENDP
```

```
Exit_Configuration_Mode PROC NEAR  
MOV AX,0202h  
CALL Write_Configuration_Data
```

RET

Exit_Configuration_Mode ENDP

Check_Chip PROC NEAR

MOV AL,20h

CALL Read_Configuration_Data

CMP AL,87h

JNE Not_Initial

MOV AL,21h

CALL Read_Configuration_Data

CMP AL,12h

JNE Not_Initial

Need_Initial:

STC

RET

Not_Initial:

CLC

RET

Check_Chip ENDP

Read_Configuration_Data PROC NEAR

MOV DX,WORD PTR CS:[Cfg_Port+04h]

OUT DX,AL

```
MOV DX,WORD PTR CS:[Cfg_Port+06h]
IN AL,DX
RET
Read_Configuration_Data ENDP
```

```
Write_Configuration_Data PROC NEAR
MOV DX,WORD PTR CS:[Cfg_Port+04h]
OUT DX,AL
XCHG AL,AH
MOV DX,WORD PTR CS:[Cfg_Port+06h]
OUT DX,AL
RET
Write_Configuration_Data ENDP
```

```
Superio_Set_Reg proc near
push ax
MOV DX,WORD PTR CS:[Cfg_Port+04h]
mov al,cl
out dx,al
pop ax
inc dx
out dx,al
ret
Superio_Set_Reg endp.Set_Logic_Device proc near
Set_Logic_Device proc near
```

```
push ax
push cx
xchg al,cl
mov cl,07h
call Superio_Set_Reg
pop cx
pop ax
ret
Set_Logic_Device endp
```

```
;Select 02Eh->Index Port, 02Fh->Data Port
Cfg_Port DB 087h,001h,055h,055h
```

```
DW 02Eh,02Fh
```

END Main

Note: Interrupt level mapping

0Fh-Dh: not valid

0Ch: IRQ12

.

.

03h: IRQ3

02h: not valid

01h: IRQ1

00h: no interrupt selected







































Appendix

B

I/O Information

B.1 I/O Address Map

Input/output (IO)
[00000000 - 0000001F] Direct memory access controller
[00000000 - 00000CF7] PCI bus
[00000010 - 0000001F] Motherboard resources
[00000020 - 00000021] Programmable interrupt controller
[00000022 - 0000003F] Motherboard resources
[00000024 - 00000025] Programmable interrupt controller
[00000028 - 00000029] Programmable interrupt controller
[0000002C - 0000002D] Programmable interrupt controller
[0000002E - 0000002F] Motherboard resources
[00000030 - 00000031] Programmable interrupt controller
[00000034 - 00000035] Programmable interrupt controller
[00000038 - 00000039] Programmable interrupt controller
[0000003C - 0000003D] Programmable interrupt controller
[00000040 - 00000043] System timer
[00000044 - 0000005F] Motherboard resources
[0000004E - 0000004F] Motherboard resources
[00000050 - 00000053] System timer
[00000060 - 00000060] Standard PS/2 Keyboard
[00000061 - 00000061] Motherboard resources
[00000062 - 00000063] Motherboard resources
[00000063 - 00000063] Motherboard resources
[00000064 - 00000064] Standard PS/2 Keyboard
[00000065 - 00000065] Motherboard resources
[00000065 - 0000006F] Motherboard resources
[00000067 - 00000067] Motherboard resources
[00000070 - 00000070] Motherboard resources
[00000070 - 00000077] System CMOS/real time clock
[00000072 - 0000007F] Motherboard resources
[00000080 - 00000080] Motherboard resources
[00000080 - 00000080] Motherboard resources
[00000081 - 00000091] Direct memory access controller
[00000084 - 00000086] Motherboard resources
[00000088 - 00000088] Motherboard resources
[0000008C - 0000008E] Motherboard resources
[00000090 - 0000009F] Motherboard resources
[00000092 - 00000092] Motherboard resources
[00000093 - 0000009F] Direct memory access controller
[000000A0 - 000000A1] Programmable interrupt controller
[000000A2 - 000000BF] Motherboard resources
[000000A4 - 000000A5] Programmable interrupt controller
[000000A8 - 000000A9] Programmable interrupt controller

























































	[000000AC - 000000AD] Programmable interrupt controller
	[000000B0 - 000000B1] Programmable interrupt controller
	[000000B2 - 000000B3] Motherboard resources
	[000000B4 - 000000B5] Programmable interrupt controller
	[000000B8 - 000000B9] Programmable interrupt controller
	[000000BC - 000000BD] Programmable interrupt controller
	[000000C0 - 000000DF] Direct memory access controller
	[000000E0 - 000000EF] Motherboard resources
	[000000F0 - 000000FF] Numeric data processor
	[00000200 - 0000020F] Motherboard resources
	[000002F8 - 000002FF] Communications Port (COM2)
	[000003B0 - 000003BB] Intel(R) HD Graphics 4000
	[000003C0 - 000003DF] Intel(R) HD Graphics 4000
	[000003F8 - 000003FF] Communications Port (COM1)
	[00000400 - 00000453] Motherboard resources
	[00000454 - 00000457] Motherboard resources
	[00000458 - 0000047F] Motherboard resources
	[000004D0 - 000004D1] Motherboard resources
	[000004D0 - 000004D1] Programmable interrupt controller
	[00000500 - 0000057F] Motherboard resources
	[00000680 - 0000069F] Motherboard resources
	[00000A00 - 00000A1F] Motherboard resources
	[00000A20 - 00000A2F] Motherboard resources
	[00000A30 - 00000A3F] Motherboard resources
	[00000D00 - 0000FFFF] PCI bus
	[0000164E - 0000164F] Motherboard resources
	[0000E000 - 0000E0FF] Realtek PCIe GBE Family Controller
	[0000E000 - 0000EFFF] Intel(R) 7 Series/C216 Chipset Family PCI Express Root Port 2 - 1E12
	[0000F000 - 0000F03F] Intel(R) HD Graphics 4000
	[0000F040 - 0000F05F] Intel(R) 7 Series/C216 Chipset Family SMBus Host Controller - 1E22
	[0000F060 - 0000F07F] Intel(R) 7 Series/C216 Chipset Family SATA AHCI Controller - 1E03
	[0000F0A0 - 0000F0A3] Intel(R) 7 Series/C216 Chipset Family SATA AHCI Controller - 1E03
	[0000F0B0 - 0000F0B7] Intel(R) 7 Series/C216 Chipset Family SATA AHCI Controller - 1E03
	[0000F0C0 - 0000F0C3] Intel(R) 7 Series/C216 Chipset Family SATA AHCI Controller - 1E03
	[0000F0D0 - 0000F0D7] Intel(R) 7 Series/C216 Chipset Family SATA AHCI Controller - 1E03
	[0000F0E0 - 0000F0E7] Intel(R) Active Management Technology - SOL (COM5)
	[0000FFFF - 0000FFFF] Motherboard resources
	[0000FFFF - 0000FFFF] Motherboard resources

B.2 Memory Address Map

Address Range	Device Name
[000A0000 - 000BFFFF]	Intel(R) HD Graphics 4000
[000A0000 - 000BFFFF]	PCI bus
[000D0000 - 000D3FFF]	PCI bus
[000D4000 - 000D7FFF]	PCI bus
[000D8000 - 000DBFFF]	PCI bus
[000DC000 - 000DFFFF]	PCI bus
[000E0000 - 000E3FFF]	PCI bus
[000E4000 - 000E7FFF]	PCI bus
[20000000 - 201FFFFFF]	System board
[3DA00000 - 3DA00FFF]	Motherboard resources
[3DA00000 - FEAF0000]	PCI bus
[40004000 - 40004FFF]	System board
[E0000000 - EFFFFFFF]	Intel(R) HD Graphics 4000
[F0000000 - F0003FFF]	Realtek PCIe GBE Family Controller
[F0000000 - F00FFFFFF]	Intel(R) 7 Series/C216 Chipset Family PCI Express Root Port 2 - 1E12
[F7800000 - F7BFFFFFF]	Intel(R) HD Graphics 4000
[F7C00000 - F7C00FFF]	Realtek PCIe GBE Family Controller
[F7C00000 - F7C00FFF]	Intel(R) 7 Series/C216 Chipset Family PCI Express Root Port 2 - 1E12
[F7D00000 - F7D1FFFF]	Intel(R) 82579LM Gigabit Network Connection
[F7D20000 - F7D2FFFF]	Intel(R) USB 3.0 eXtensible Host Controller
[F7D30000 - F7D33FFF]	High Definition Audio Controller
[F7D35000 - F7D350FF]	Intel(R) 7 Series/C216 Chipset Family SMBus Host Controller - 1E22
[F7D36000 - F7D367FF]	Intel(R) 7 Series/C216 Chipset Family SATA AHCI Controller - 1E03
[F7D37000 - F7D373FF]	Intel(R) 7 Series/C216 Chipset Family USB Enhanced Host Controller - 1E26
[F7D38000 - F7D383FF]	Intel(R) 7 Series/C216 Chipset Family USB Enhanced Host Controller - 1E2D
[F7D39000 - F7D39FFF]	Intel(R) 82579LM Gigabit Network Connection
[F7D3A000 - F7D3AFFF]	Intel(R) Active Management Technology - SOL (COM5)
[F7D3C000 - F7D3C00F]	Intel(R) Management Engine Interface
[F8000000 - FBFFFFFF]	Motherboard resources
[FED00000 - FED003FF]	High precision event timer
[FED10000 - FED17FFF]	Motherboard resources
[FED18000 - FED18FFF]	Motherboard resources
[FED19000 - FED19FFF]	Motherboard resources
[FED1C000 - FED1FFFF]	Motherboard resources
[FED20000 - FED3FFFF]	Motherboard resources
[FED40000 - FED44FFF]	System board
[FED45000 - FED8FFFF]	Motherboard resources
[FED90000 - FED93FFF]	Motherboard resources
[FEE00000 - FEEFFFFFF]	Motherboard resources
[FF000000 - FFFFFFFF]	Intel(R) 82802 Firmware Hub Device
[FF000000 - FFFFFFFF]	Motherboard resources

B.3 IRQ Mapping Chart

Interrupt request (IRQ)	Device
(ISA) 0x00000000 (00)	System timer
(ISA) 0x00000001 (01)	Standard PS/2 Keyboard
(ISA) 0x00000003 (03)	Communications Port (COM2)
(ISA) 0x00000004 (04)	Communications Port (COM1)
(ISA) 0x00000008 (08)	System CMOS/real time clock
(ISA) 0x0000000C (12)	Microsoft PS/2 Mouse
(ISA) 0x0000000D (13)	Numeric data processor
(ISA) 0x00000051 (81)	Microsoft ACPI-Compliant System
(ISA) 0x00000052 (82)	Microsoft ACPI-Compliant System
(ISA) 0x00000053 (83)	Microsoft ACPI-Compliant System
(ISA) 0x00000054 (84)	Microsoft ACPI-Compliant System
(ISA) 0x00000055 (85)	Microsoft ACPI-Compliant System
(ISA) 0x00000056 (86)	Microsoft ACPI-Compliant System
(ISA) 0x00000057 (87)	Microsoft ACPI-Compliant System
(ISA) 0x00000058 (88)	Microsoft ACPI-Compliant System
(ISA) 0x00000059 (89)	Microsoft ACPI-Compliant System
(ISA) 0x0000005A (90)	Microsoft ACPI-Compliant System
(ISA) 0x0000005B (91)	Microsoft ACPI-Compliant System
(ISA) 0x0000005C (92)	Microsoft ACPI-Compliant System
(ISA) 0x0000005D (93)	Microsoft ACPI-Compliant System
(ISA) 0x0000005E (94)	Microsoft ACPI-Compliant System
(ISA) 0x0000005F (95)	Microsoft ACPI-Compliant System
(ISA) 0x00000060 (96)	Microsoft ACPI-Compliant System
(ISA) 0x00000061 (97)	Microsoft ACPI-Compliant System
(ISA) 0x00000062 (98)	Microsoft ACPI-Compliant System
(ISA) 0x00000063 (99)	Microsoft ACPI-Compliant System
(ISA) 0x00000064 (100)	Microsoft ACPI-Compliant System
(ISA) 0x00000065 (101)	Microsoft ACPI-Compliant System
(ISA) 0x00000066 (102)	Microsoft ACPI-Compliant System
(ISA) 0x00000067 (103)	Microsoft ACPI-Compliant System
(ISA) 0x00000068 (104)	Microsoft ACPI-Compliant System
(ISA) 0x00000069 (105)	Microsoft ACPI-Compliant System
(ISA) 0x0000006A (106)	Microsoft ACPI-Compliant System
(ISA) 0x0000006B (107)	Microsoft ACPI-Compliant System
(ISA) 0x0000006C (108)	Microsoft ACPI-Compliant System
(ISA) 0x0000006D (109)	Microsoft ACPI-Compliant System
(ISA) 0x0000006E (110)	Microsoft ACPI-Compliant System
(ISA) 0x0000006F (111)	Microsoft ACPI-Compliant System
(ISA) 0x00000070 (112)	Microsoft ACPI-Compliant System
(ISA) 0x00000071 (113)	Microsoft ACPI-Compliant System
(ISA) 0x00000072 (114)	Microsoft ACPI-Compliant System
(ISA) 0x00000073 (115)	Microsoft ACPI-Compliant System
(ISA) 0x00000074 (116)	Microsoft ACPI-Compliant System
(ISA) 0x00000075 (117)	Microsoft ACPI-Compliant System
(ISA) 0x00000076 (118)	Microsoft ACPI-Compliant System

 (ISA) 0x00000077 (119)	Microsoft ACPI-Compliant System
 (ISA) 0x00000078 (120)	Microsoft ACPI-Compliant System
 (ISA) 0x00000079 (121)	Microsoft ACPI-Compliant System
 (ISA) 0x0000007A (122)	Microsoft ACPI-Compliant System
 (ISA) 0x0000007B (123)	Microsoft ACPI-Compliant System
 (ISA) 0x0000007C (124)	Microsoft ACPI-Compliant System
 (ISA) 0x0000007D (125)	Microsoft ACPI-Compliant System
 (ISA) 0x0000007E (126)	Microsoft ACPI-Compliant System
 (ISA) 0x0000007F (127)	Microsoft ACPI-Compliant System
 (ISA) 0x00000080 (128)	Microsoft ACPI-Compliant System
 (ISA) 0x00000081 (129)	Microsoft ACPI-Compliant System
 (ISA) 0x00000082 (130)	Microsoft ACPI-Compliant System
 (ISA) 0x00000083 (131)	Microsoft ACPI-Compliant System
 (ISA) 0x00000084 (132)	Microsoft ACPI-Compliant System
 (ISA) 0x00000085 (133)	Microsoft ACPI-Compliant System
 (ISA) 0x00000086 (134)	Microsoft ACPI-Compliant System
 (ISA) 0x00000087 (135)	Microsoft ACPI-Compliant System
 (ISA) 0x00000088 (136)	Microsoft ACPI-Compliant System
 (ISA) 0x00000089 (137)	Microsoft ACPI-Compliant System
 (ISA) 0x0000008A (138)	Microsoft ACPI-Compliant System
 (ISA) 0x0000008B (139)	Microsoft ACPI-Compliant System
 (ISA) 0x0000008C (140)	Microsoft ACPI-Compliant System
 (ISA) 0x0000008D (141)	Microsoft ACPI-Compliant System
 (ISA) 0x0000008E (142)	Microsoft ACPI-Compliant System
 (ISA) 0x0000008F (143)	Microsoft ACPI-Compliant System
 (ISA) 0x00000090 (144)	Microsoft ACPI-Compliant System
 (ISA) 0x00000091 (145)	Microsoft ACPI-Compliant System
 (ISA) 0x00000092 (146)	Microsoft ACPI-Compliant System
 (ISA) 0x00000093 (147)	Microsoft ACPI-Compliant System
 (ISA) 0x00000094 (148)	Microsoft ACPI-Compliant System
 (ISA) 0x00000095 (149)	Microsoft ACPI-Compliant System
 (ISA) 0x00000096 (150)	Microsoft ACPI-Compliant System
 (ISA) 0x00000097 (151)	Microsoft ACPI-Compliant System
 (ISA) 0x00000098 (152)	Microsoft ACPI-Compliant System
 (ISA) 0x00000099 (153)	Microsoft ACPI-Compliant System
 (ISA) 0x0000009A (154)	Microsoft ACPI-Compliant System
 (ISA) 0x0000009B (155)	Microsoft ACPI-Compliant System
 (ISA) 0x0000009C (156)	Microsoft ACPI-Compliant System
 (ISA) 0x0000009D (157)	Microsoft ACPI-Compliant System
 (ISA) 0x0000009E (158)	Microsoft ACPI-Compliant System
 (ISA) 0x0000009F (159)	Microsoft ACPI-Compliant System
 (ISA) 0x000000A0 (160)	Microsoft ACPI-Compliant System
 (ISA) 0x000000A1 (161)	Microsoft ACPI-Compliant System
 (ISA) 0x000000A2 (162)	Microsoft ACPI-Compliant System
 (ISA) 0x000000A3 (163)	Microsoft ACPI-Compliant System
 (ISA) 0x000000A4 (164)	Microsoft ACPI-Compliant System
 (ISA) 0x000000A5 (165)	Microsoft ACPI-Compliant System
 (ISA) 0x000000A6 (166)	Microsoft ACPI-Compliant System
 (ISA) 0x000000A7 (167)	Microsoft ACPI-Compliant System
 (ISA) 0x000000A8 (168)	Microsoft ACPI-Compliant System
 (ISA) 0x000000A9 (169)	Microsoft ACPI-Compliant System
 (ISA) 0x000000AA (170)	Microsoft ACPI-Compliant System
 (ISA) 0x000000AB (171)	Microsoft ACPI-Compliant System
 (ISA) 0x000000AC (172)	Microsoft ACPI-Compliant System
 (ISA) 0x000000AD (173)	Microsoft ACPI-Compliant System
 (ISA) 0x000000AE (174)	Microsoft ACPI-Compliant System
 (ISA) 0x000000AF (175)	Microsoft ACPI-Compliant System

(ISA) 0x000000B0 (176)	Microsoft ACPI-Compliant System
(ISA) 0x000000B1 (177)	Microsoft ACPI-Compliant System
(ISA) 0x000000B2 (178)	Microsoft ACPI-Compliant System
(ISA) 0x000000B3 (179)	Microsoft ACPI-Compliant System
(ISA) 0x000000B4 (180)	Microsoft ACPI-Compliant System
(ISA) 0x000000B5 (181)	Microsoft ACPI-Compliant System
(ISA) 0x000000B6 (182)	Microsoft ACPI-Compliant System
(ISA) 0x000000B7 (183)	Microsoft ACPI-Compliant System
(ISA) 0x000000B8 (184)	Microsoft ACPI-Compliant System
(ISA) 0x000000B9 (185)	Microsoft ACPI-Compliant System
(ISA) 0x000000BA (186)	Microsoft ACPI-Compliant System
(ISA) 0x000000BB (187)	Microsoft ACPI-Compliant System
(ISA) 0x000000BC (188)	Microsoft ACPI-Compliant System
(ISA) 0x000000BD (189)	Microsoft ACPI-Compliant System
(ISA) 0x000000BE (190)	Microsoft ACPI-Compliant System
(PCI) 0x0000000B (11)	Intel(R) 7 Series/C216 Chipset Family SMBus Host Controller - 1E22
(PCI) 0x00000010 (16)	Intel(R) 7 Series/C216 Chipset Family USB Enhanced Host Controller - 1E2D
(PCI) 0x00000010 (16)	Intel(R) Management Engine Interface
(PCI) 0x00000013 (19)	Intel(R) 7 Series/C216 Chipset Family SATA AHCI Controller - 1E03
(PCI) 0x00000013 (19)	Intel(R) Active Management Technology - SOL (COM5)
(PCI) 0x00000016 (22)	High Definition Audio Controller
(PCI) 0x00000017 (23)	Intel(R) 7 Series/C216 Chipset Family USB Enhanced Host Controller - 1E26
(PCI) 0xFFFFFFF9 (-7)	Realtek PCIe GBE Family Controller
(PCI) 0xFFFFF7FA (-6)	Intel(R) 82579LM Gigabit Network Connection
(PCI) 0xFFFFF7F5 (-5)	Intel(R) USB 3.0 eXtensible Host Controller
(PCI) 0xFFFFF7FC (-4)	Intel(R) HD Graphics 4000
(PCI) 0xFFFFF7FD (-3)	Intel(R) 7 Series/C216 Chipset Family PCI Express Root Port 2 - 1E12
(PCI) 0xFFFFF7FE (-2)	Intel(R) 7 Series/C216 Chipset Family PCI Express Root Port 1 - 1E10

B.4 DMA Channel Assignments

Direct memory access (DMA)	
4	Direct memory access controller

Appendix

C

Mating Connector

C.1 List of Mating Connectors and Cables

The table notes mating connectors and available cables.

Connector Label	Function	Mating Connector		Available Cable	Cable P/N
		Vendor	Model No.		
CN5	LVDS Connector	E-call	0110-01-553-300	N/A	N/A
CN6	LVDS Inverter Connector	Catch	1192-700-05S	N/A	N/A
CN8	CRT Connector	Astron	26-4101-208-1G-R	N/A	N/A
CN9	DP Connector	Foxconn	3VD21203-H7U0-4H	N/A	N/A
CN10	DP Connector	Kortak	9S020F-03AS-00H	N/A	N/A
CN11	COM2 Port / DVI Connector	Kortak	8H0380-065C-00H	N/A	N/A
CN12	HDMI Connector	Lotes	GSP-ABA-HDM-013-K09	N/A	N/A
CN13	MiniCard Connector	Kortak	EM052H-0850-2R	N/A	N/A
CN14	CFast Connector	3M	N7G24-A0B2RA-10-0HT-DY	N/A	N/A
PCIE1	PCIEx16 Connector	Kortak	EE082C0-Y3Z	N/A	N/A
ATX1	+12V V-IN Connector	Catch	1121-700-04S	N/A	N/A
CPU_FAN1	CPU_FAN Connector	Pinrex	744-81-04TG20	N/A	N/A
SYS_FAN1	SYS_FAN Connector	Pinrex	744-81-04TG20	N/A	N/A
PWR1	SATA PWR Connector	Ho-base	P201-04	SATA PWR Cable	1702151200
PWR2	SATA PWR Connector	Ho-base	P201-04	SATA PWR	1702151200

				Cable	
COM1	COM1 Port Connector	Pinrex	52C-90-10G BE0	N/A	N/A
DIO1	Digital I/O Connector	Astron	27-24041-20 5-1G-TB1-R	N/A	N/A
USB1	USB Port Connector	Astron	27-24041-20 5-1G-TB1-R	USB Cable	1709100201
USB2	USB Port Connector	Astron	27-24041-20 5-1G-TB1-R	USB Cable	1709100201
USB3	USB Port Connector	Astron	27-24041-20 5-1G-TB1-R	USB Cable	1709100201
SATA1	SATA Connector	Lotes	ABA-SAT-04 6-K12	SATA Cable	1709070800
SATA2	SATA Connector	Lotes	ABA-SAT-04 6-K12	SATA Cable	1709070800
SATA3	SATA Connector	Lotes	ABA-SAT-04 6-K12	SATA Cable	1709070800
SATA4	SATA Connector	Lotes	ABA-SAT-04 6-K12	SATA Cable	1709070800
KM1	Keyboard / Mouse Connector	Foxconn	MH11061-P 36-4F	N/A	N/A
USB_LAN 1	RJ-45 Ethernet#1 / USB3.0 Connector	Ude	05-000939M 23-1	N/A	N/A
USB_LAN 2	RJ-45 Ethernet#2/ USB3.0 Connector	Ude	05-000939M 23-1	N/A	N/A
Audio1	Audio In/Out/CD-in and MIC Connector	Kortak	JZ013M-10F D-B0H	N/A	N/A

Appendix

D

**RAID & AHCI
Settings**

D.1 Setting RAID

OS installation to setup RAID Mode

Step 1: Copy the files below from “**Driver CD ->Step 6 - RAID&AHCI -> F6 Floppy - x86**” to Disk



Step 2: Connect the USB Floppy (disk with RAID files) to the board



Step 3: The setting procedures "In BIOS Setup Menu"

A: Advanced -> SATA Configuration -> SATA Mode -> RAID Mode

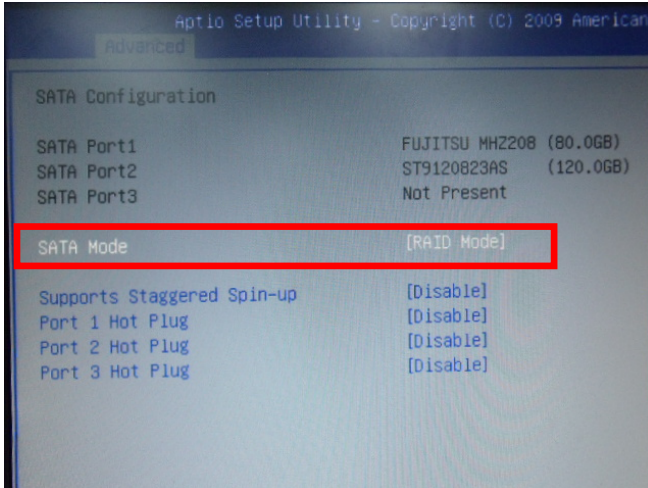

Step 4: The setting procedures "In BIOS Setup Menu"

B: Advanced -> Launch Storage OpROM -> Enabled

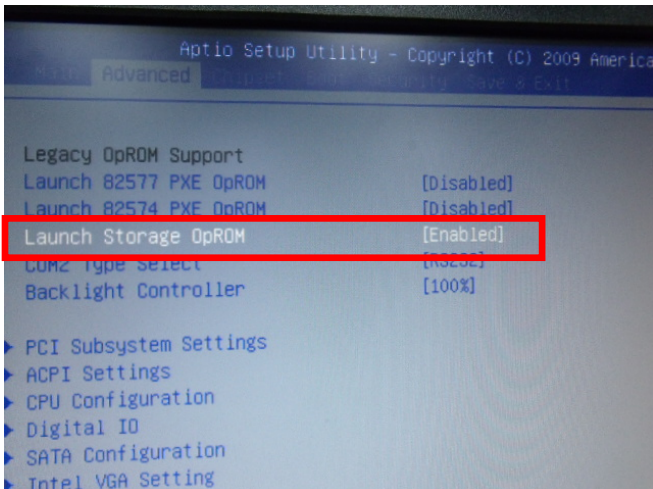

Step 5: The setting procedures "In BIOS Setup Menu"

C: Boot -> Boot Option #1 -> DVD-ROM Type

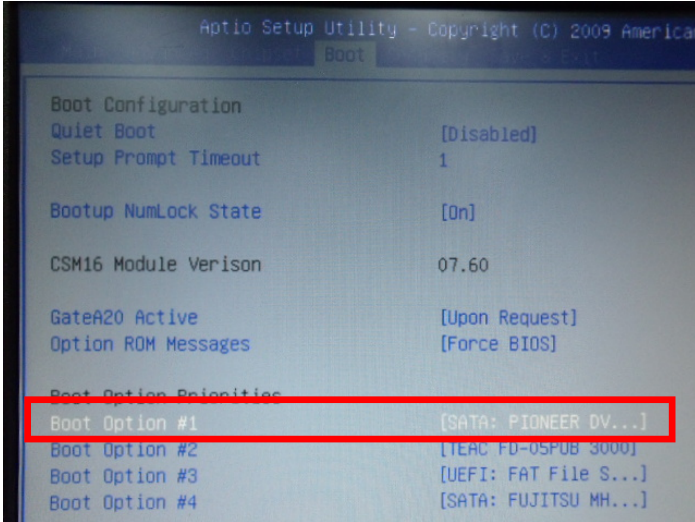

Step 6: The setting procedures "In BIOS Setup Menu"

D: Save & Exit -> Save Changes and Exit

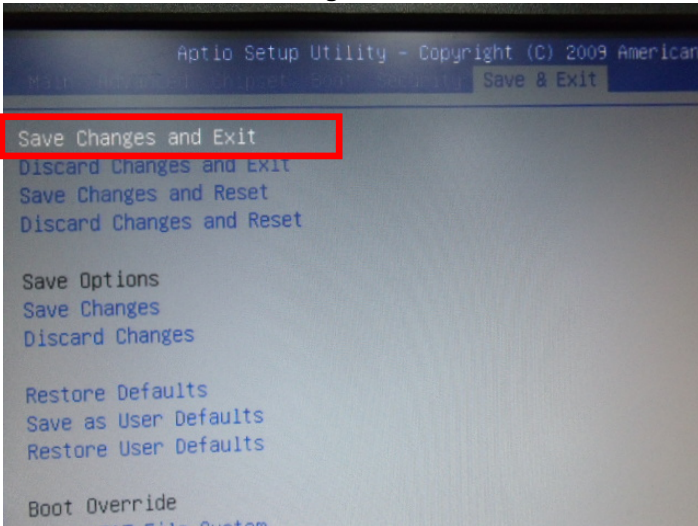

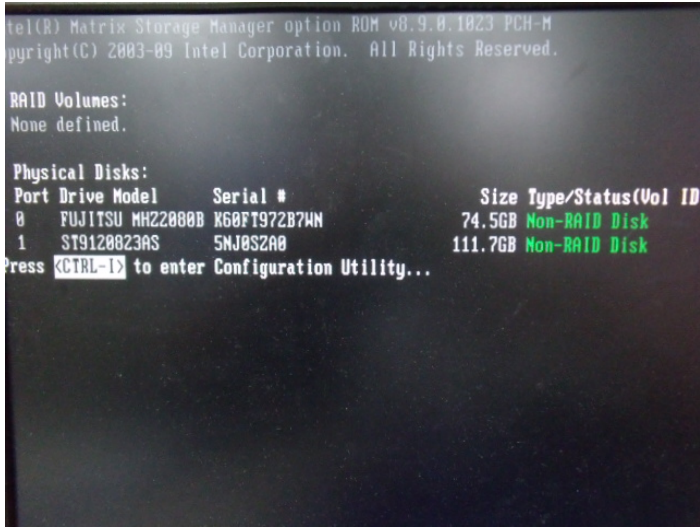
Step 7: Press **Ctrl-I** to enter **MAIN MENU**

Step 8: Choose "1.Create RAID Volume"

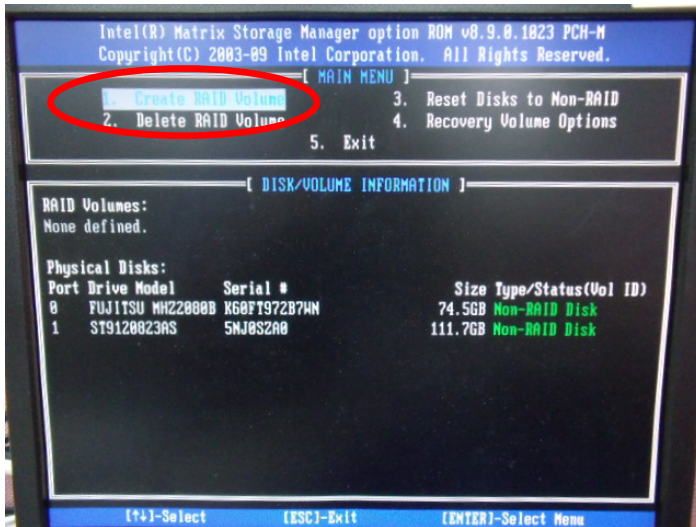

Step 9: RAID Level -> RAID0(Stripe)

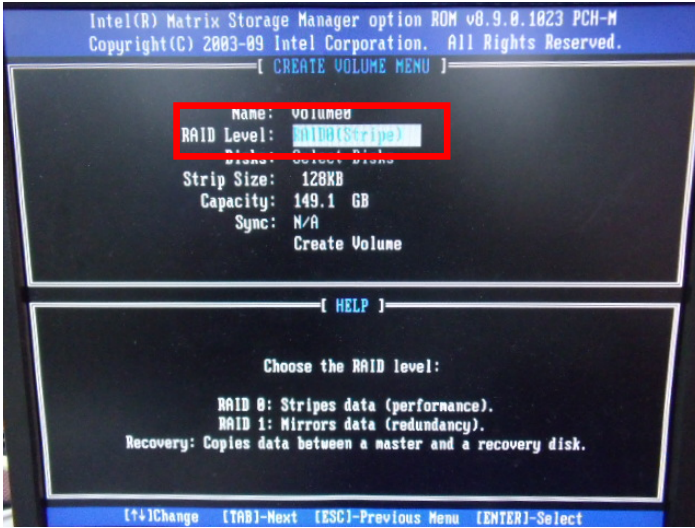

Step 10: Choose "Create Volume"

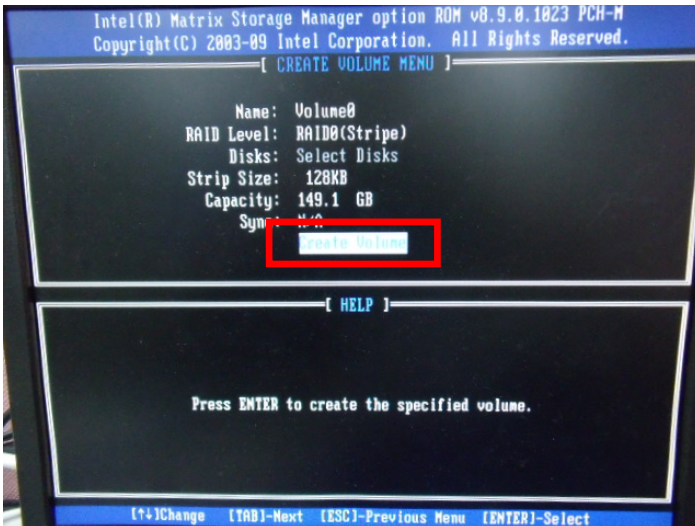

Step 11: Choose "Y"

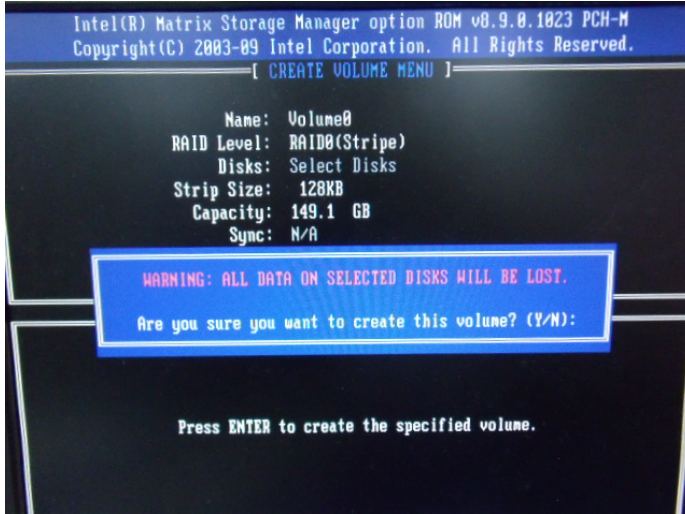

Step 12: Choose "5. Exit"

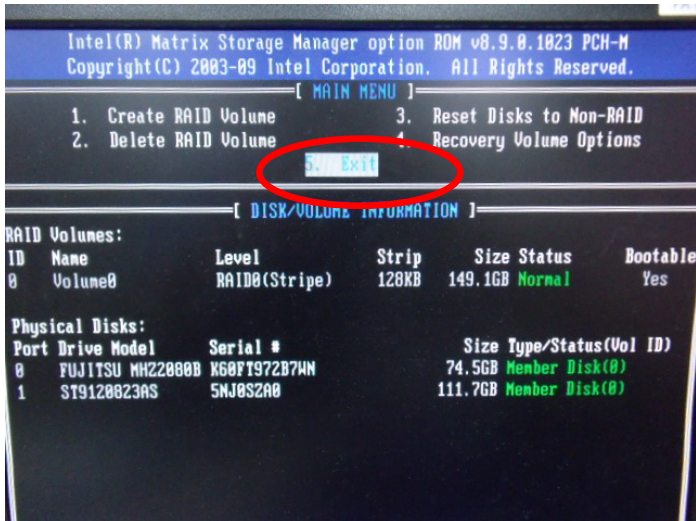

Step 13: Choose “Y”

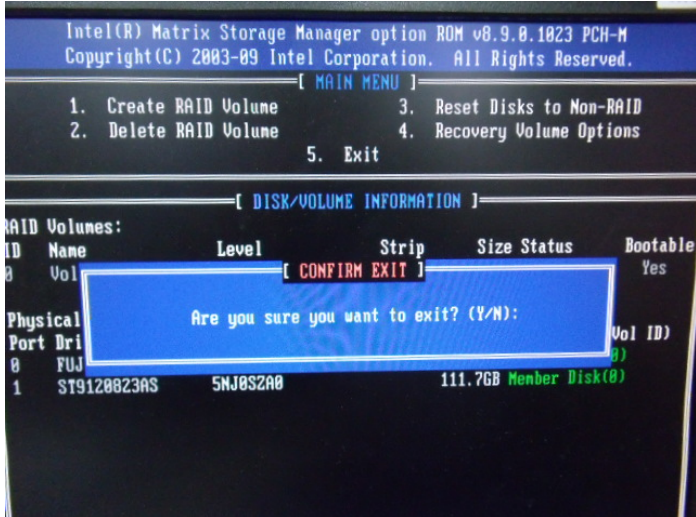

Step 14: Setup OS

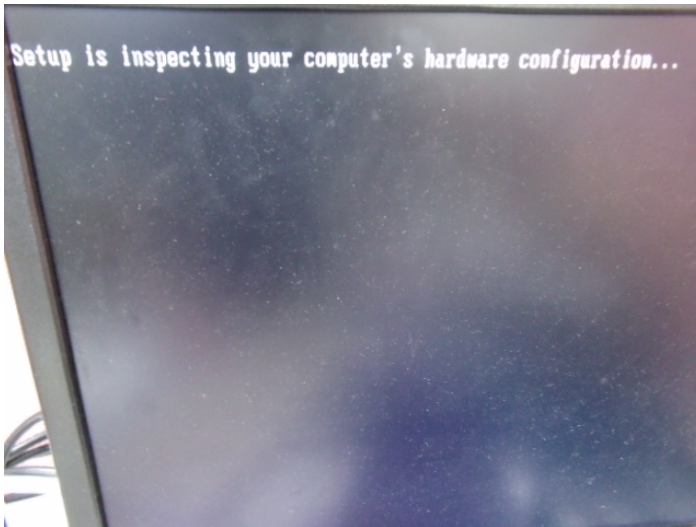

Step 15: Press “F6”



Step 16: Choose “S”

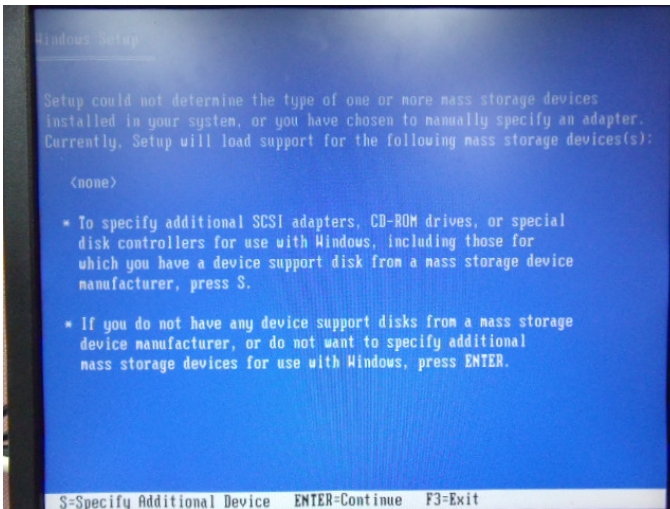

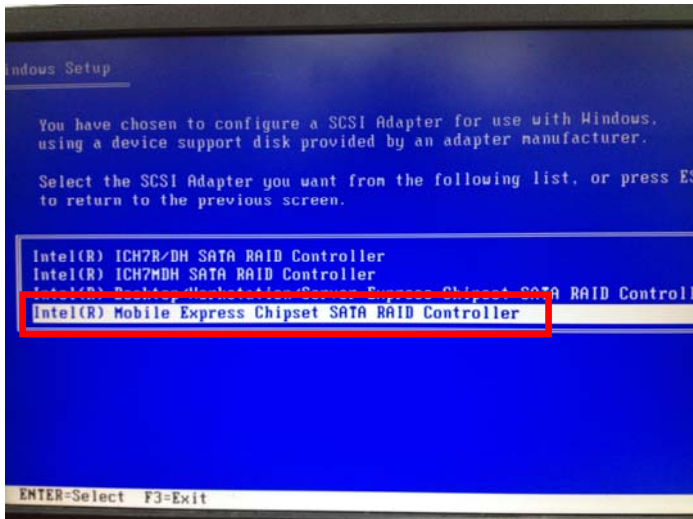
Step 17: Choose “Intel(R) Mobile Express Chipset SATA RAID Controller”**Step 18: It will show the model number you select and then press “ENTER”**

Step 19: Setup is starting Windows

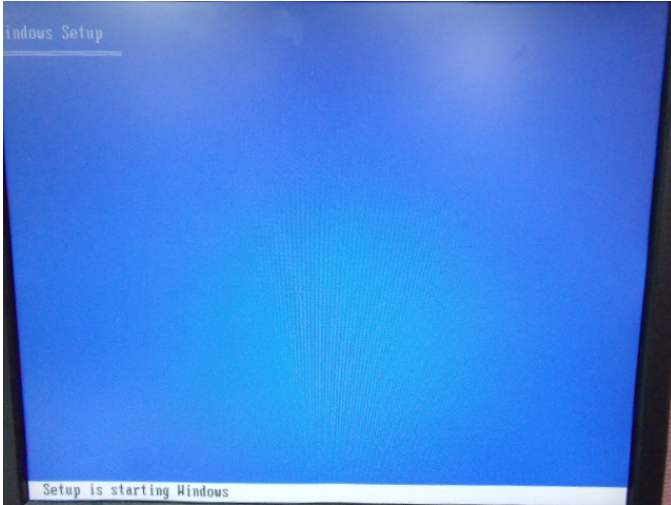

D.2 Setting AHCI

OS installation to setup AHCI Mode

Step 1: Copy the files below from “**Driver CD -> Raid Driver -> F6 Floppy - x86**” to Disk

 F6Readme 文字文件 8 KB	 iaAHCI 安全性目錄 9 KB
 iaAHCI 安裝資訊 9 KB	 iaStor 安全性目錄 8 KB
 iaStor 安裝資訊 8 KB	 iaStor 系統檔案 423 KB
 license 文字文件 5 KB	 readme 文字文件 78 KB
 TXTSETUP.OEM OEM 檔案 6 KB	

Step 2: Connect the USB Floppy (disk with RAID files) to the board



Step 3: The setting procedures “In BIOS Setup Menu”

A: Advanced -> SATA Configuration -> SATA Configuration -> SATA Mode -> AHCI Mode

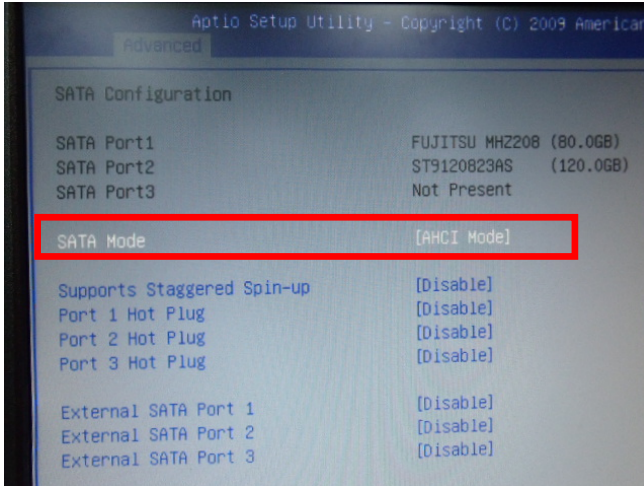

Step 4: The setting procedures “In BIOS Setup Menu”

B: Boot -> Boot Option #1 -> DVD-ROM Type

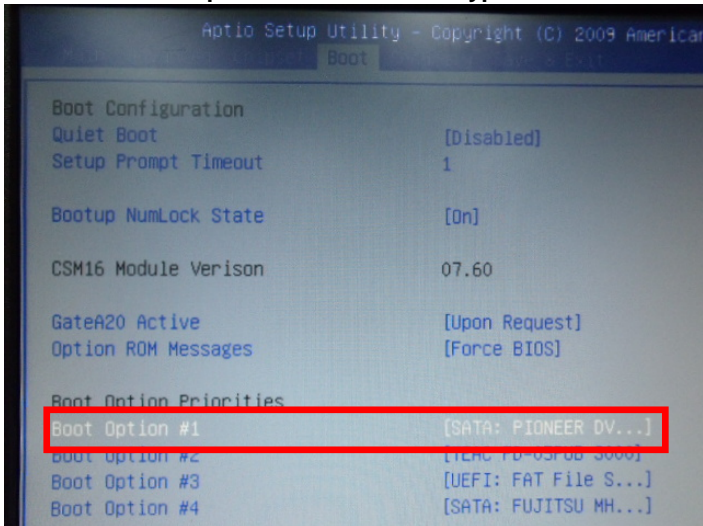

Step 5: The setting procedures "In BIOS Setup Menu"

C: Save & Exit -> Save Changes and Exit

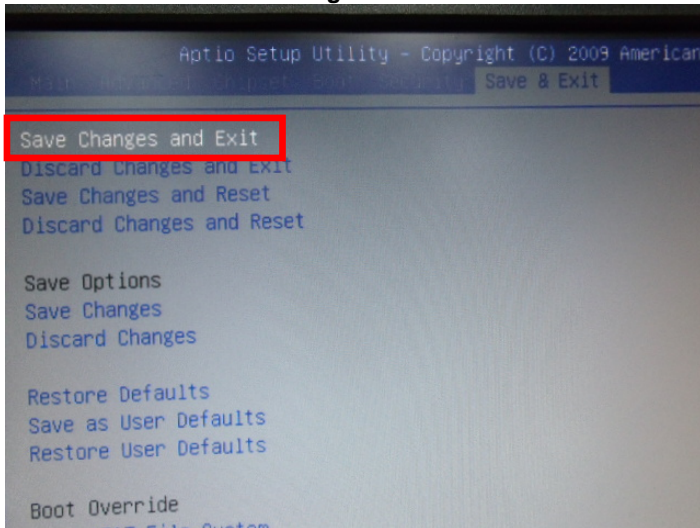

Step 6: Setup OS

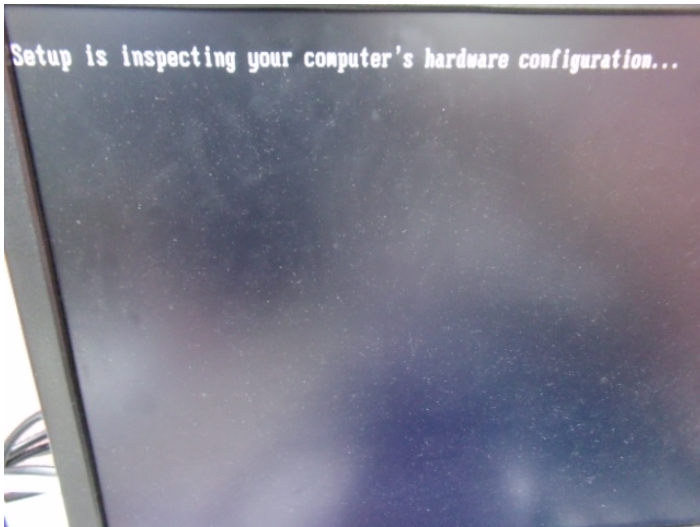

Step 7: Press "F6"



Step 8: Choose "S"

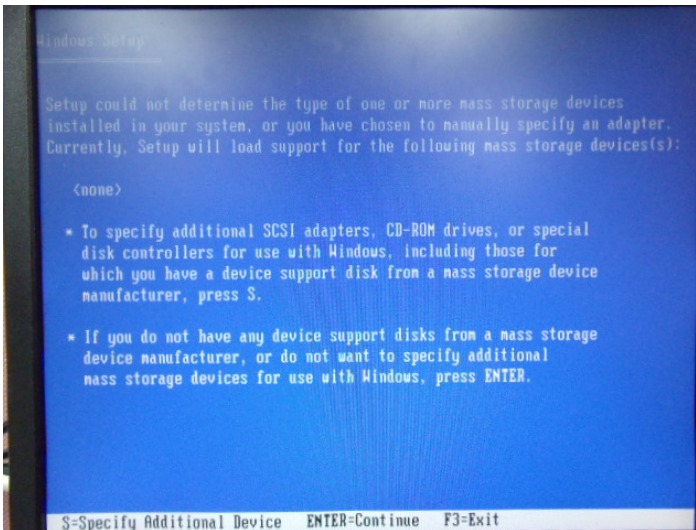

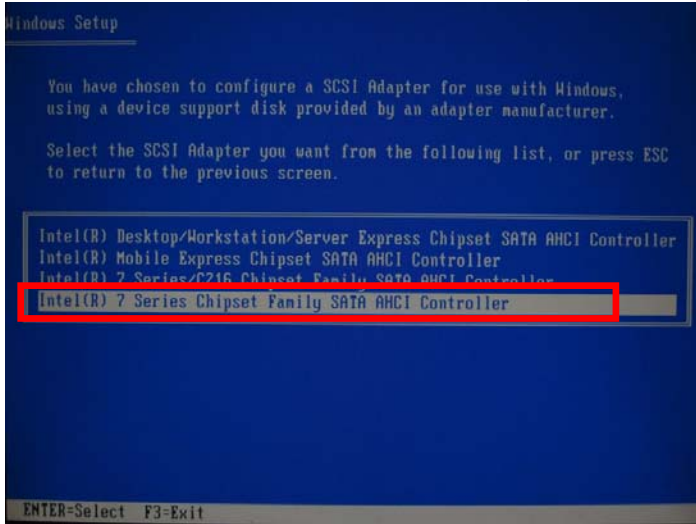
Step 9: Choose “Intel(R) 7 Series Chipset Family SATA AHCI Controller”**Step 10: It will show the model number you select and then press “ENTER”**

Step 11: Setup is loading files

